

NOVA LUCE

A
9030129 9030130

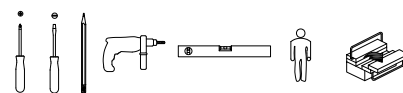

1

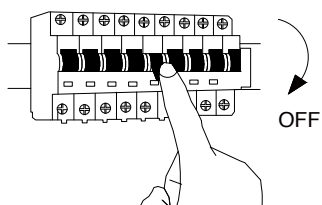

Turn off the general switch

2

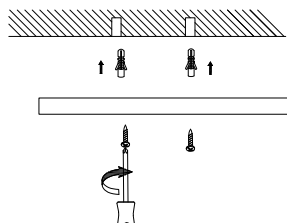

Drill holes & apply plastic anchors
With screws

3

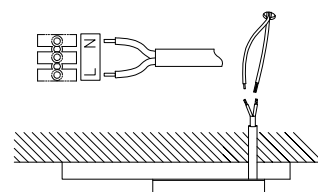

Connect the wires

4

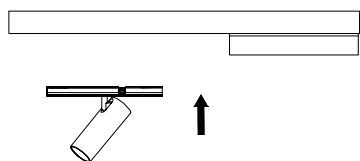

Apply the side screws

5

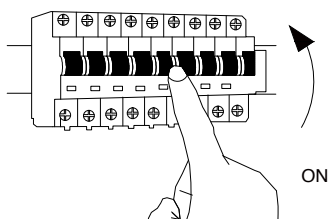

Turn on the general switch

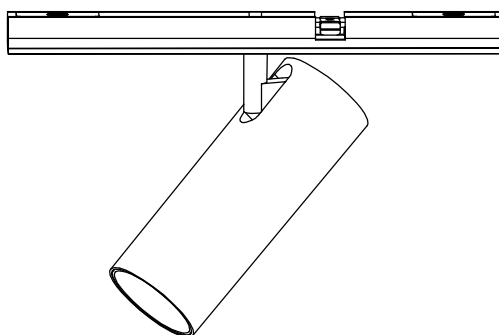

NOVA LUCE

B
9030129 9030130

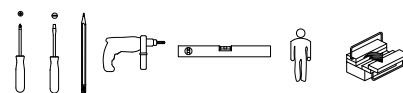

1

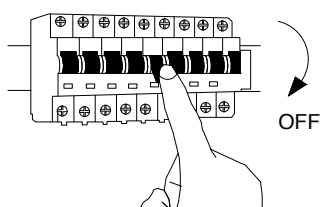

Turn off the general switch

2

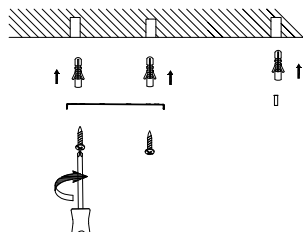

Drill holes & apply plastic anchors
With screws

3

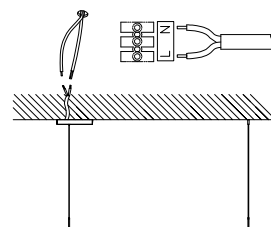

Connect the wires

4

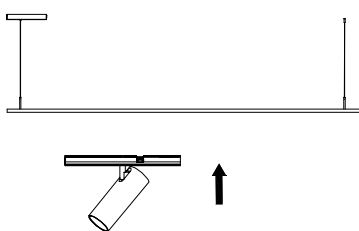

Put it in place

5

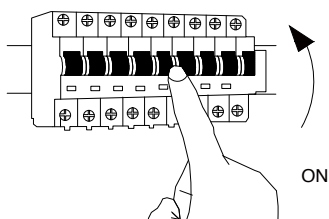

Turn on the general switch

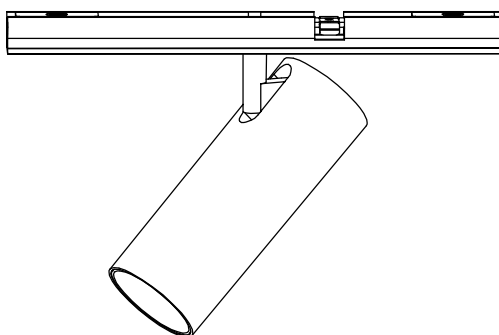

NOVA LUCE

C
9030129 9030130

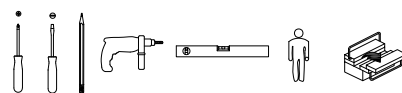

1

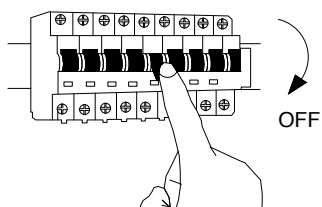

Turn off the general switch

2

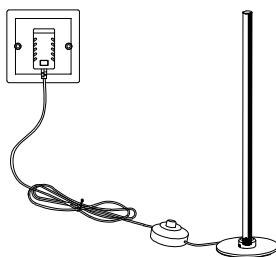

Plug it in

3

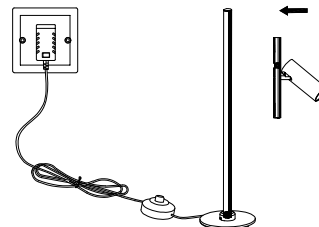

Put it in place

4

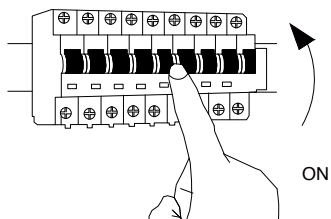

Turn on the general switch

