

1. Turn off the general switch

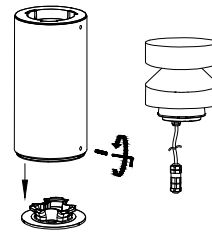

2. By rotating, break it apart

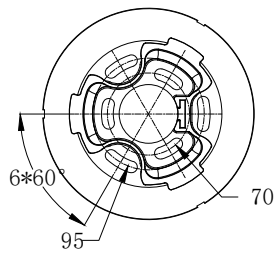

3. Align it

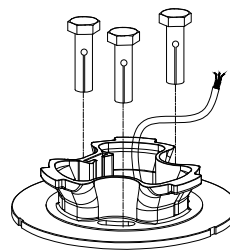

4. Apply the screws

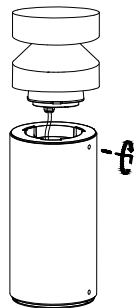

5. Apply the Side screws

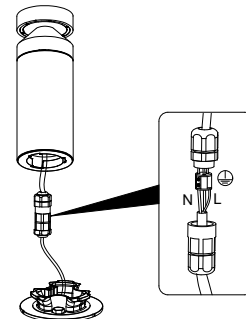

6. Connect the wires

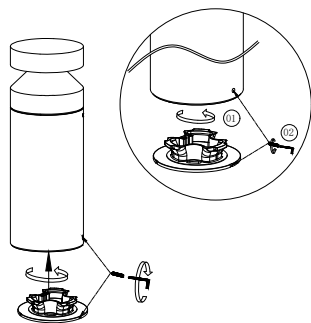

7. Put it in place and apply the side screw

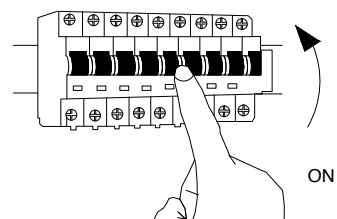

8. Turn on the general switch