

NOVA LUCE

9130638

1

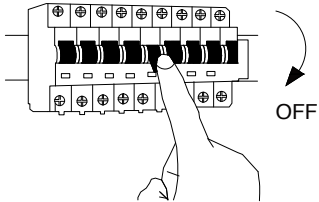

Turn off the general switch

2

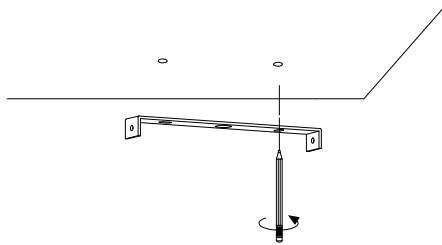

Mark where to drill holes

3

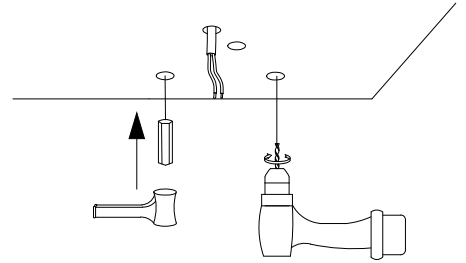

Make holes & apply anchors

4

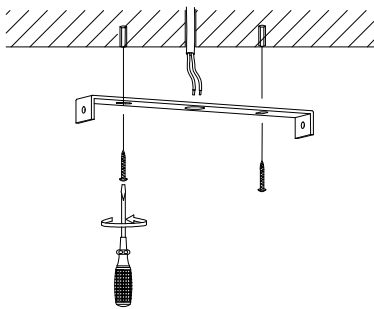

Tie up the screws to make it stable

5

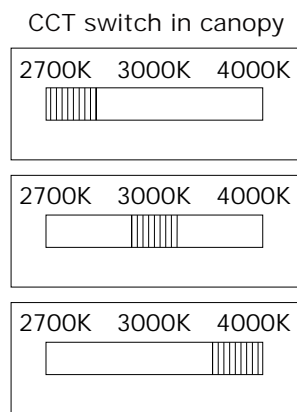

Choose the color temperature

6

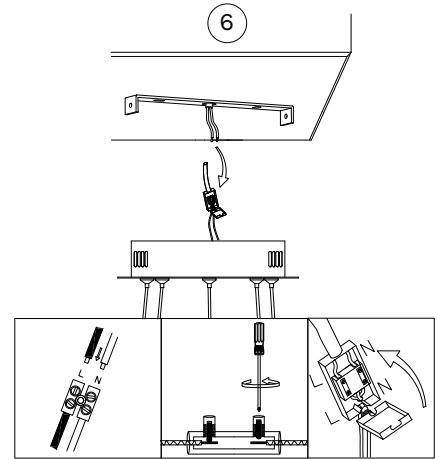

Connect the wires

7

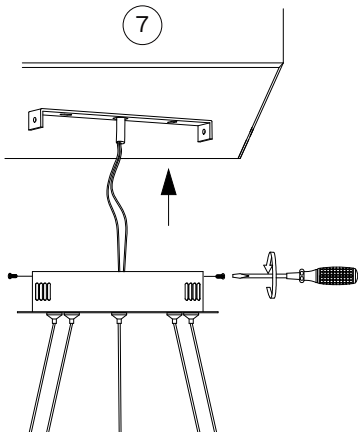

Put it in place & Apply side screws

8

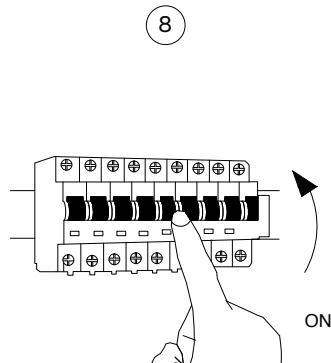

Turn on the general switch

9

