

# NOVA LUCE

9952361

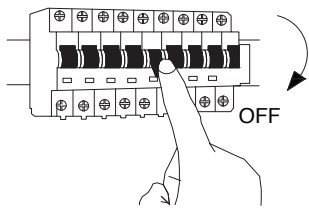

1. Turn off the general Switch

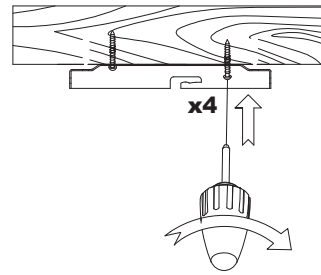

2. Apply screws

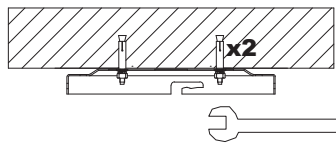

3. Tie up the screws into the anchors

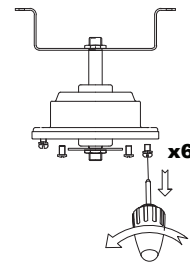

4. Connect parts by tiding up screws

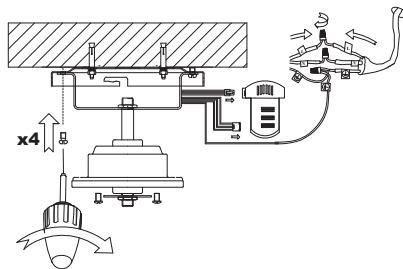

5. Apply screw & connect wires

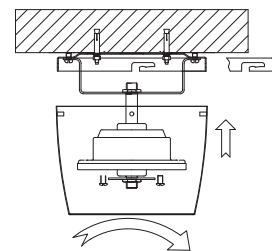

6. Apply the cap

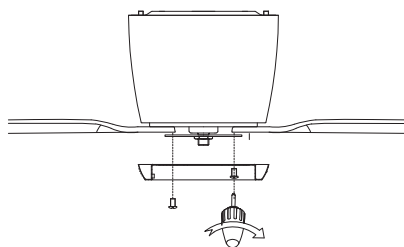

7. Apply the screws to make it stable

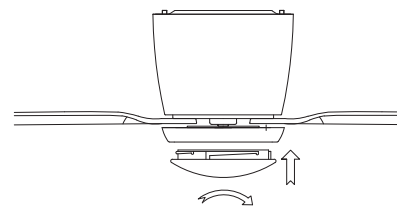

8. Insert the light

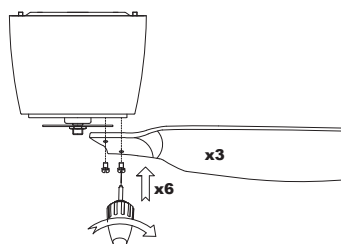

9. Attach the wings by applying the screws

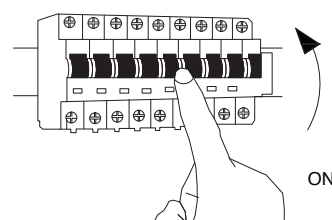







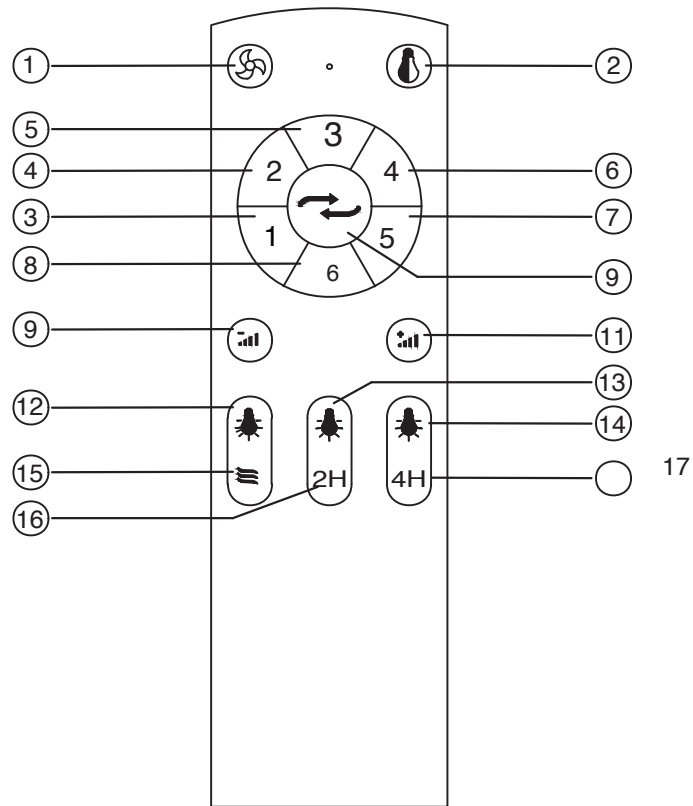









9. Turn on the general Switch

# NOVA LUCE

9952361



①	 Fan on/off
②	
③	
④	
⑤	
⑥	
⑦	
⑧	
⑨	

⑩	
⑪	
⑫	 3000K
⑬	 4000K
⑭	 5000K
⑮	 Natural wind
⑯	
⑰	

# NOVA LUCE

9952361

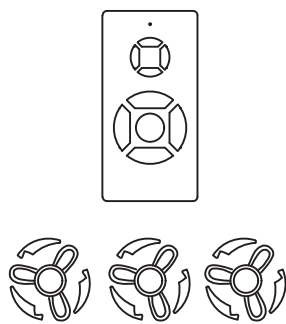
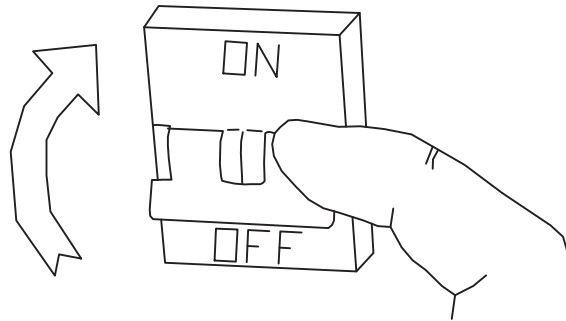

**ON**

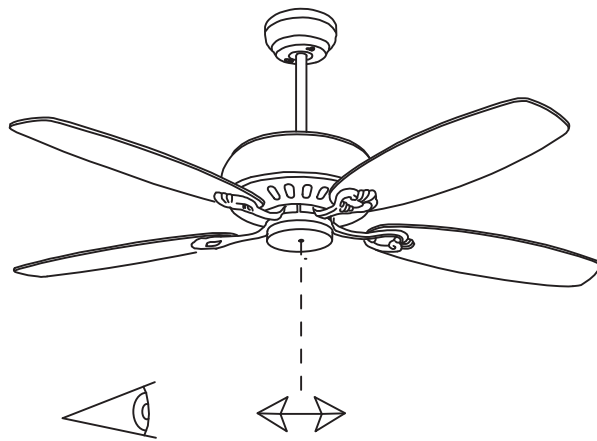

**OK**

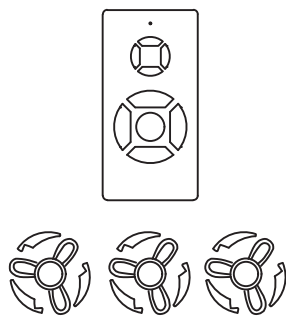

**ON**

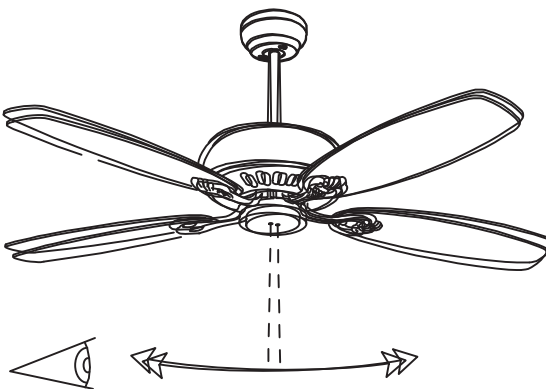

**NO**

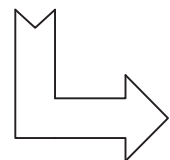

# NOVA LUCE

9952361

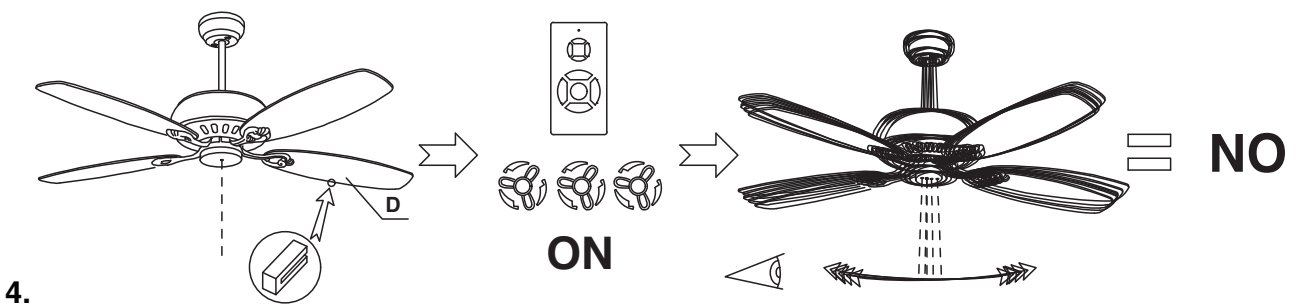
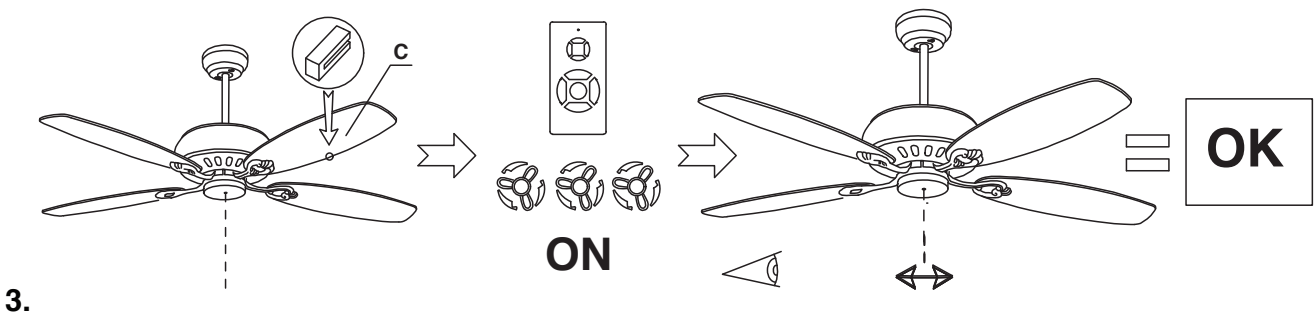
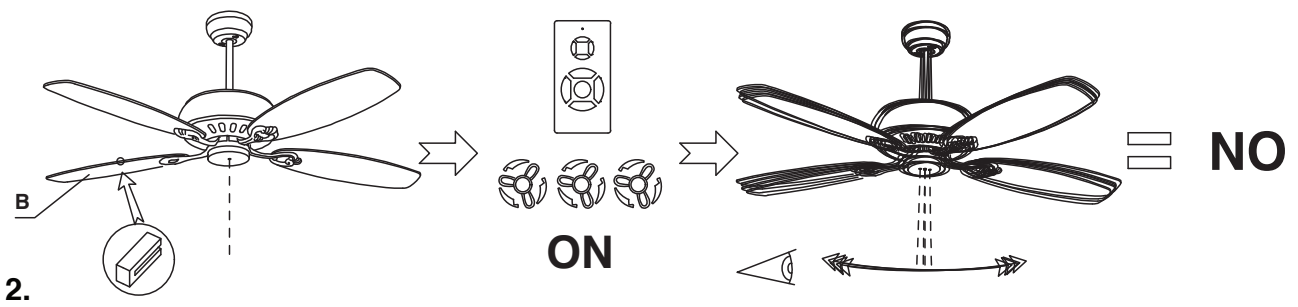
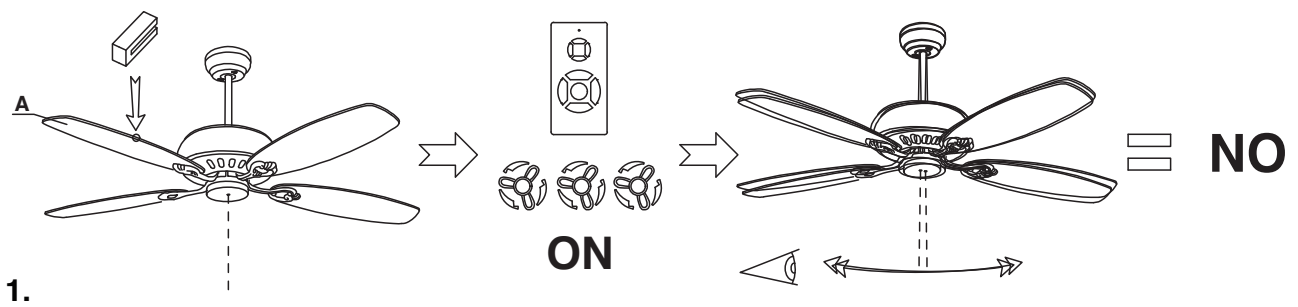
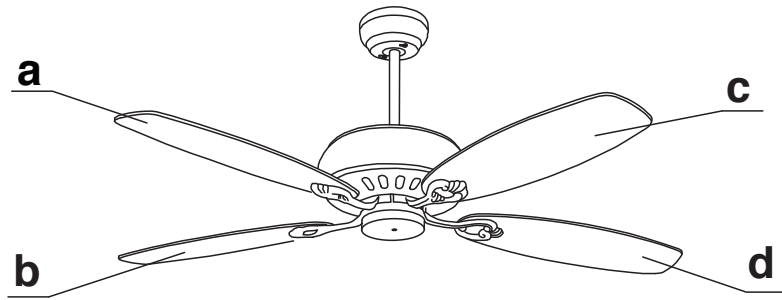

# NOVA LUCE

9952361

