

**ATTENTION: FOR THIS OPERATION YOU HAVE TO CUT OFF THE POWER**

**MAXIMUM**  
48V DC

# NOVA LUCE

Step:1

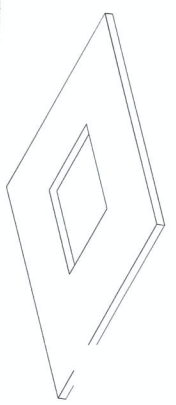

Cut out

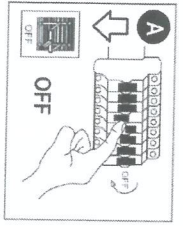

Step:4

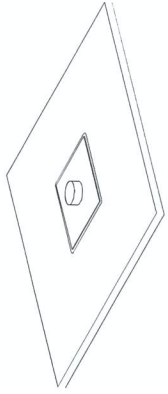

Fill up the wall cracks before plastering the pass.

Step:2

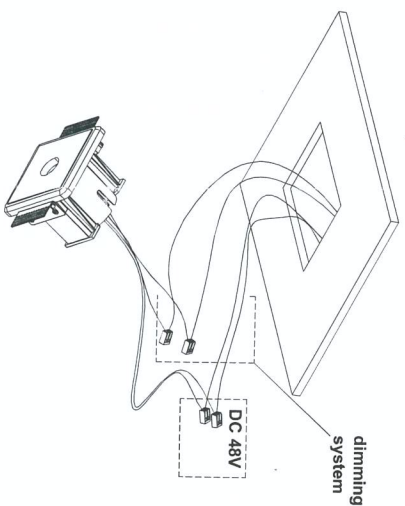

dimming system

DC 48V

Step:5

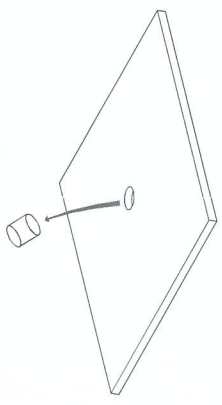

Step:3

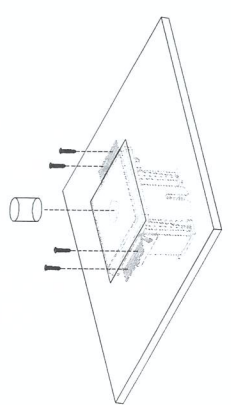

Step:6

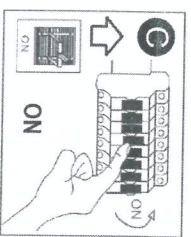

Finish

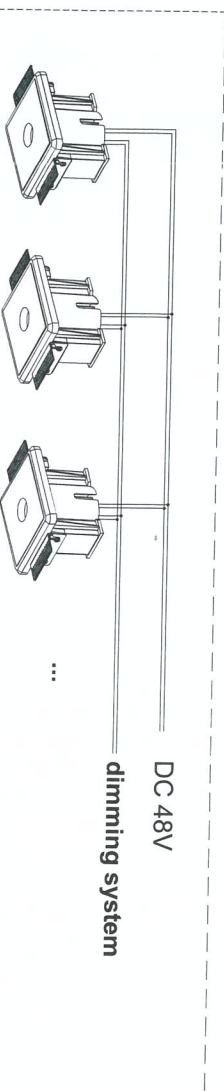

9492800