

# NOVA LUCE

5600601

1

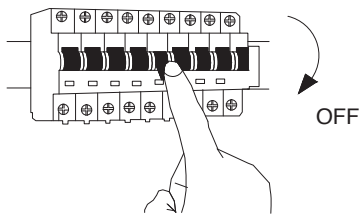

Turn off the general switch

2

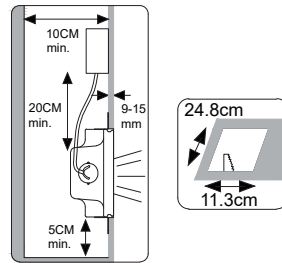

Map

3

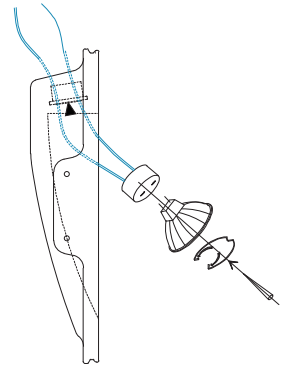

Apply the bulb in place

4

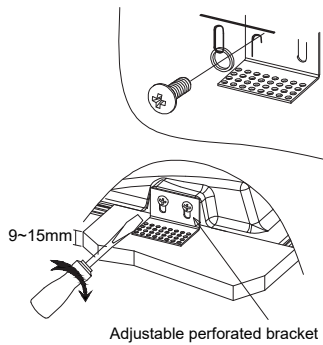

Fix it in place with a screw

5

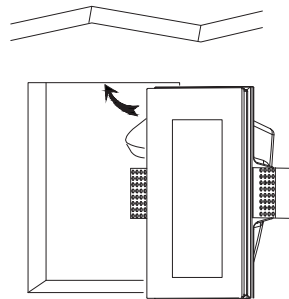

Put it in place

6

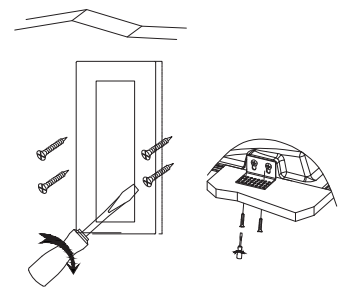

Apply screws

7

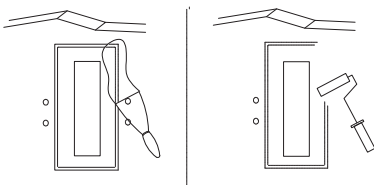

Apply putty powder & paint

8

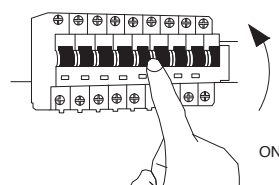

Turn on the general Switch

