

NOVA LUCE

7600601

1

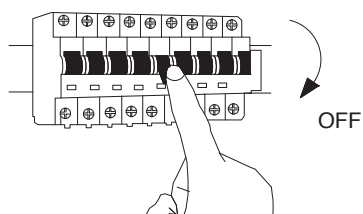

Turn off the general switch

2

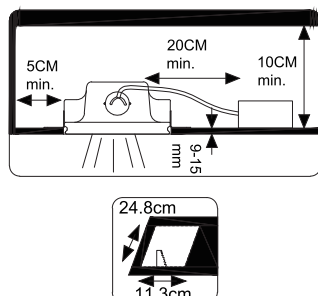

Create a CutOut

3

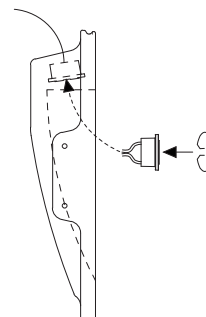

Insert the driver

4

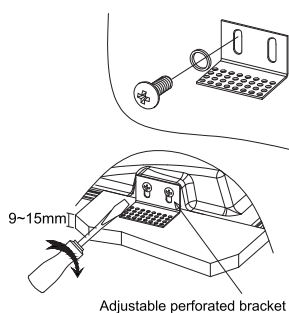

Tie up screws to assemble parts

5

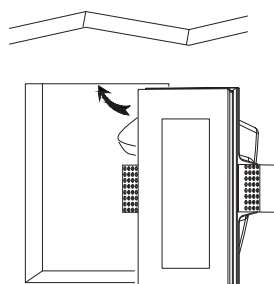

Fix it in place

6

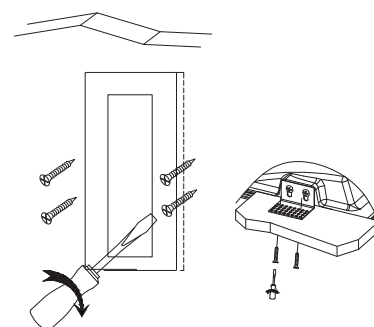

Fix it in place by tying up screws

7

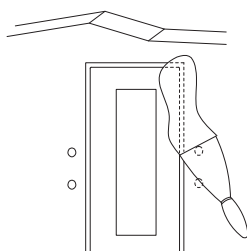

Apply putty powder

8

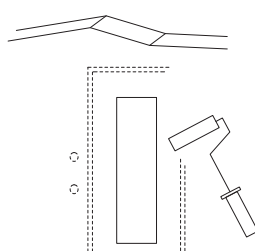

Apply paint

9

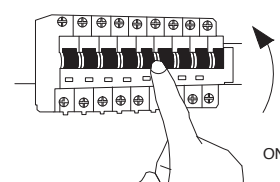

Turn on the general Switch

