

# NOVA LUCE

8105605, 8105605D, 8105615

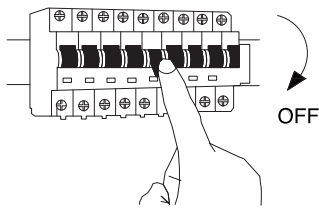

1. Turn off the general switch

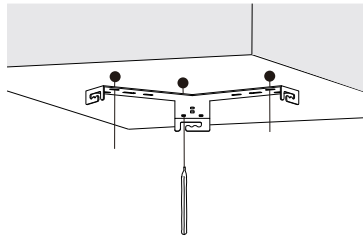

2. Mark where to drill holes

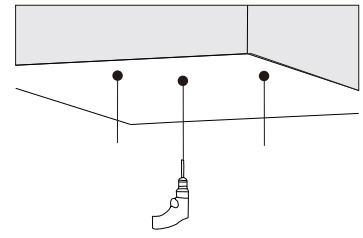

3. Drill on the marked areas

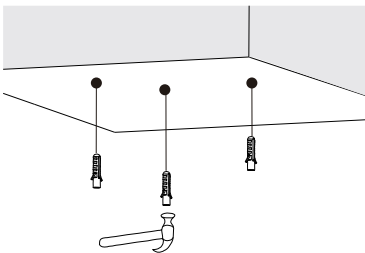

4. Apply plastic anchors

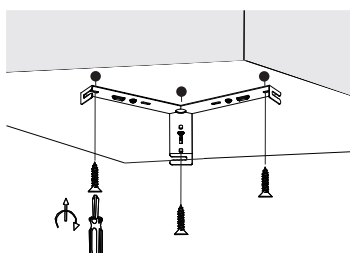

5. Apply screws

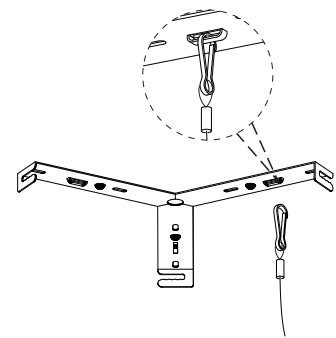

6. Make it stable

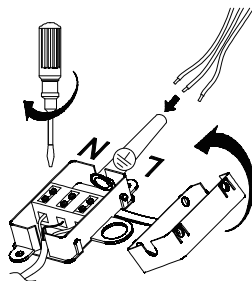

7. Connect the wires

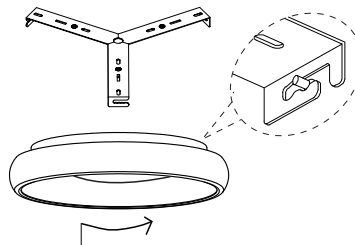

8. Apply the product by rotating

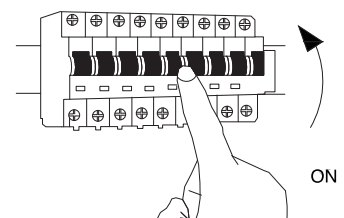

9. Turn on the general switch

