

NOVA LUCE

9136422 9136423 9136424

1

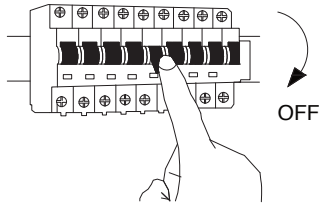

Turn off the general switch

2

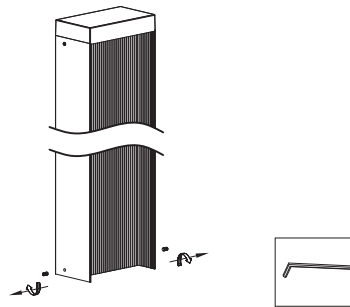

Dismantle parts by untying screws

3



Remove from the base

4

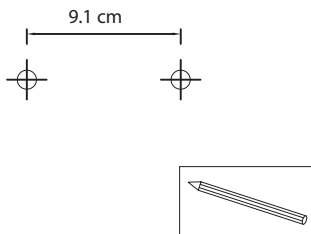

Mark holes

5

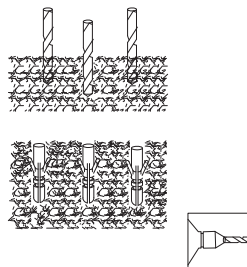

Drill holes & apply plastic anchors

6

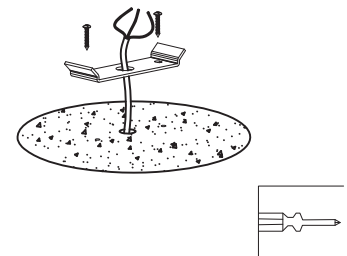

Fix the base into place by applying screws

7

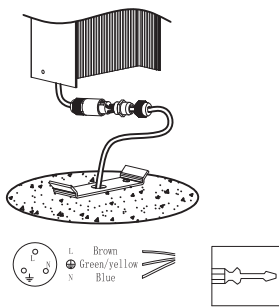

Connect wires

8

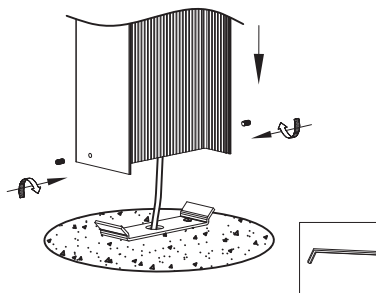

Tie up side nuts to make it stable

9

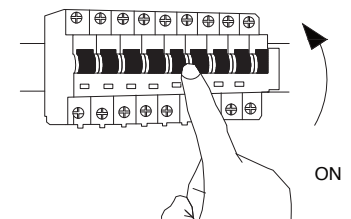

Turn on the general switch

