

NOVA LUCE

9248180

1

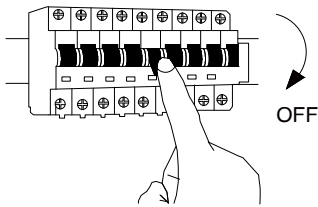

Turn off the general switch

2

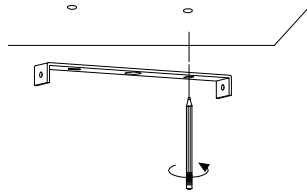

Mark holes

3

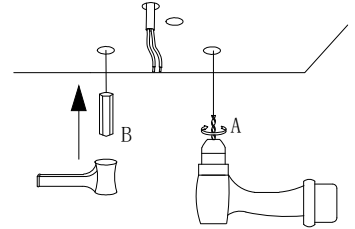

Drill holes & Apply plastic anchors

4

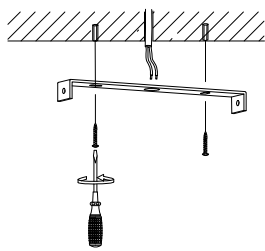

Apply screws

5

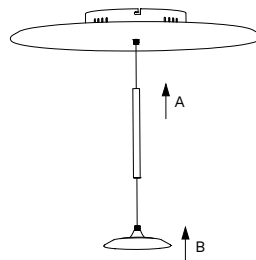

By rotating assemble it

6

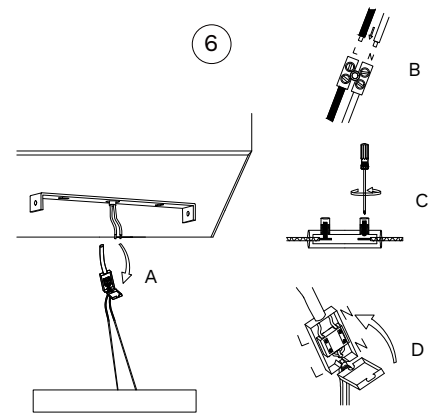

Connect the wires

7

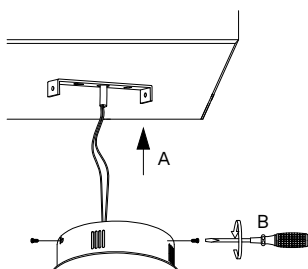

Apply the side screws

8

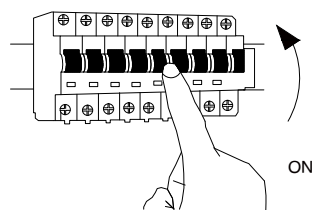

Turn on the general switch

