

NOVA LUCE

9006052

1

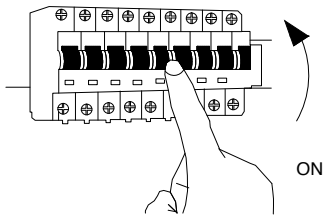

Turn off the general switch

2

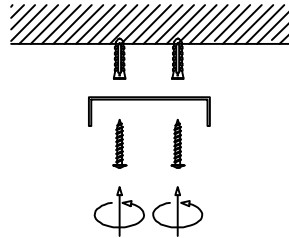

Align, mark & drill holes,
Apply plastic anchors & tie up screws

3

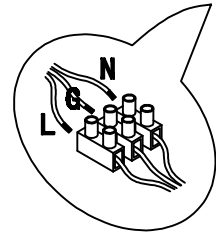

Connect wires

4

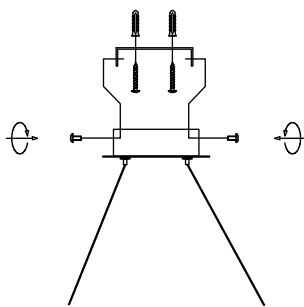

Fix it in place
by tying up side screws

5

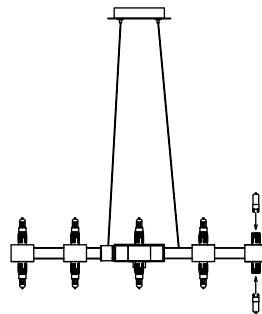

Insert the bulb

6

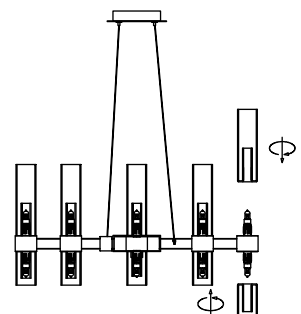

Tie up the cap by rotate

7

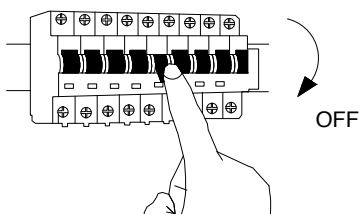

Turn on the general Switch

