

NOVA LUCE

9186971

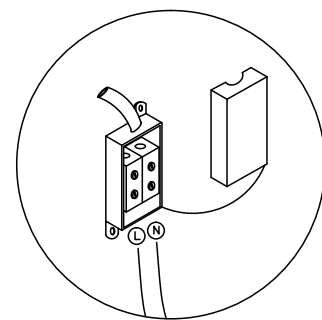

1. Turn off the general Switch
2. Align, mark and drill holes to apply the base on the ceiling
3. Connect the wires

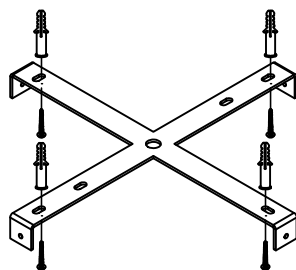
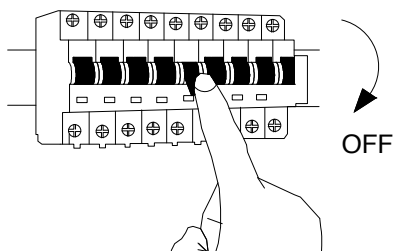
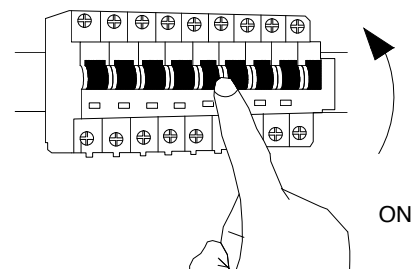
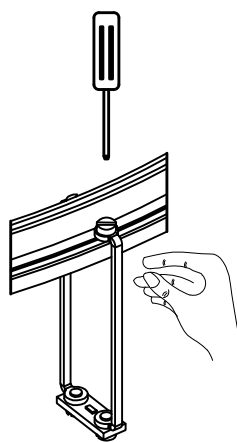
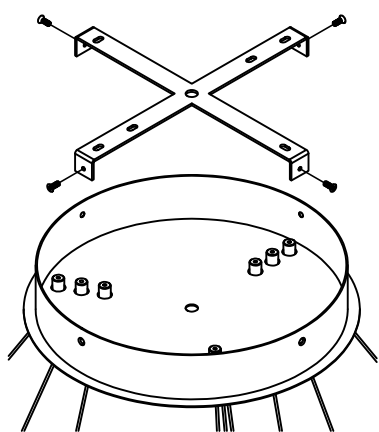

4. Fix the side screws

When the frames or LEDs are not straight, please loosen one screw and straighten them by hand, then tighten the screw.

5. Turn on the general Switch

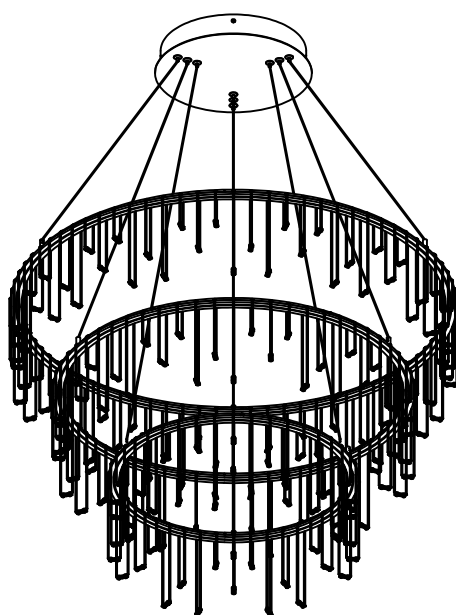

- a) This light fitting operates at a normal supply voltage of 220-240V.
- b) If the external flexible cable or cord of this luminaire is damaged. It shall be exclusively replaced by the manufacturer or his serviceagent or a similar qualified person in order to avoid a hazard.