

NOVA LUCE

9186704

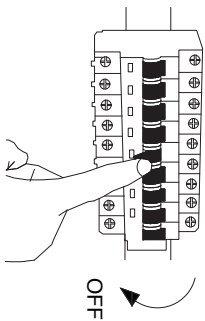

1. Turn off the general switch

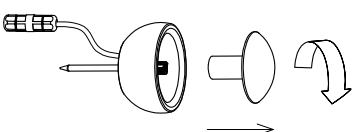

2. Drill holes

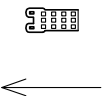

3. Apply the screws

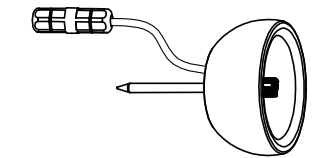

4. Connect the wires

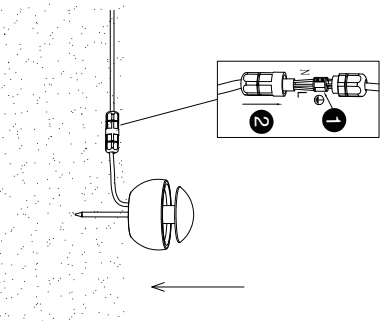
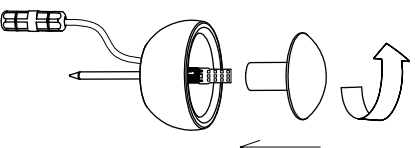

5. Make the product stable

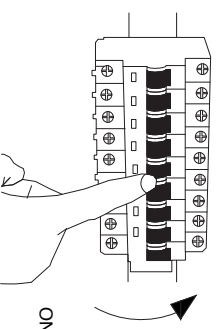

6. Turn on the general switch