

NOVA LUCE

9060111

1

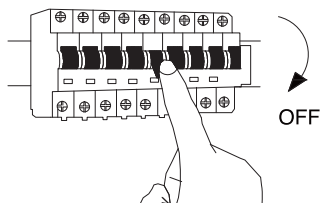

Turn off the general switch

2

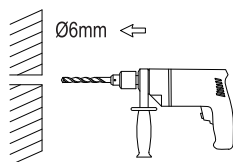

Make a 0.6 cm CutOut

3

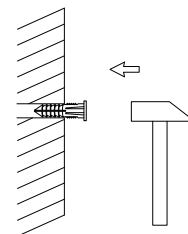

Apply plastic anchors

4

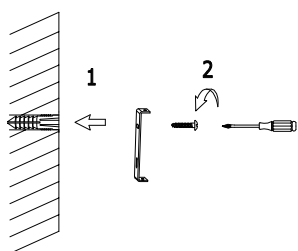

Tie up screws to fix part into place

5

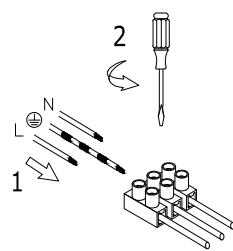

Connect the wires

6

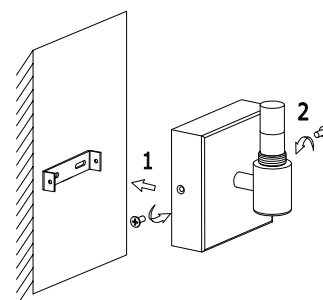

Fix it place by tying up side screws

7

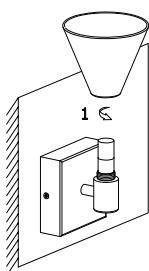

Apply the cap by rotating

8

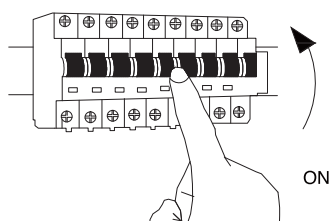

Turn on the general switch

