

# NOVA LUCE

9695126, 9695127

1

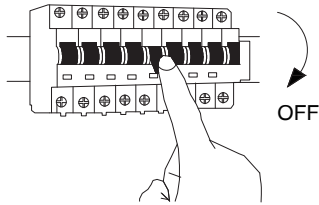

Turn off the general switch

2

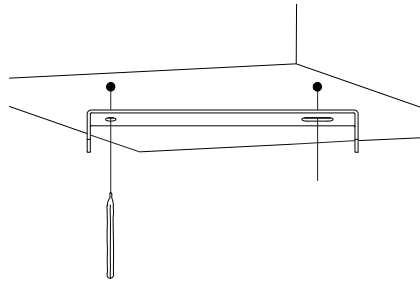

Mark holes

3

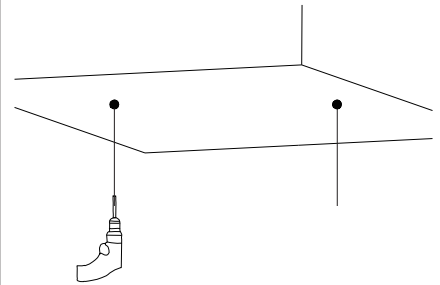

Drill holes

4

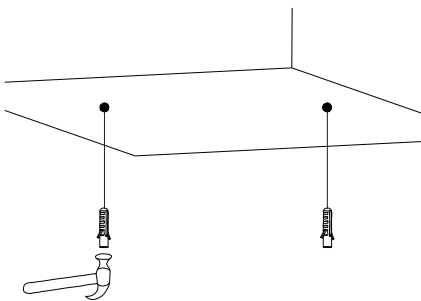

Apply plastic anchors

5

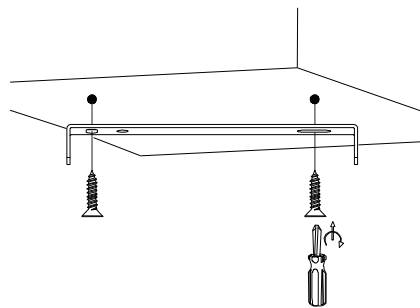

Tie up screws

6

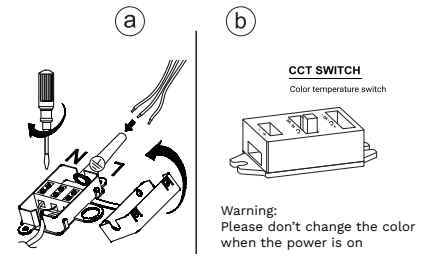

Connect wires

7

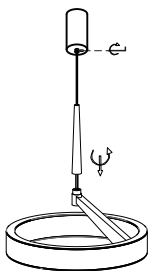

Adjust the high by tying the screw

8

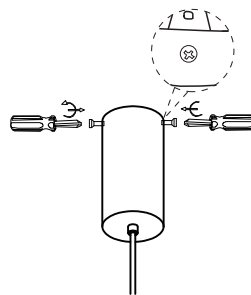

Tie up side screws  
to fix it in place

9

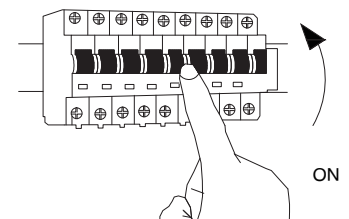

Turn on the general switch

