

NOVA LUCE

9186953

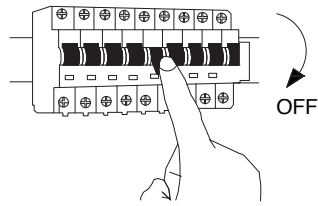

1. Turn off the general switch

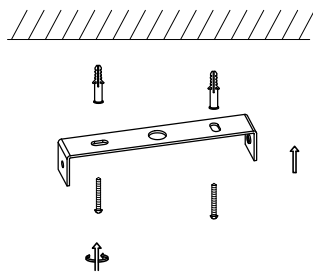

4. Drill holes and insert the screws into the base.

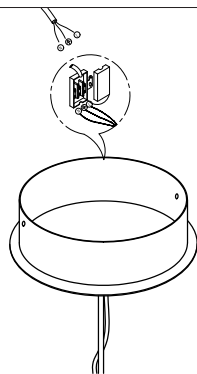

5. Connect wires.

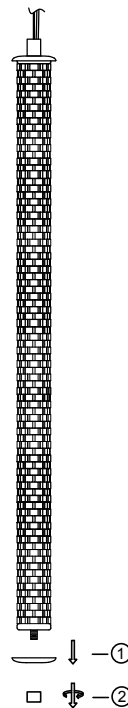

2. Unscrew the bottom part from the metal.

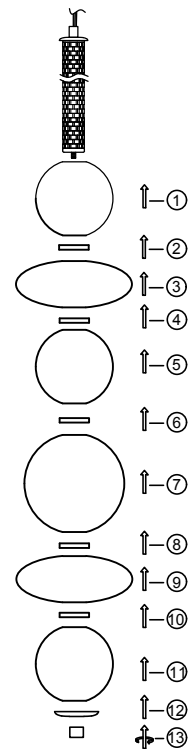

3. Insert the glasses and screw it.

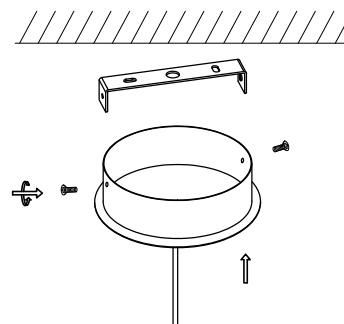

6. Tie up side screws.

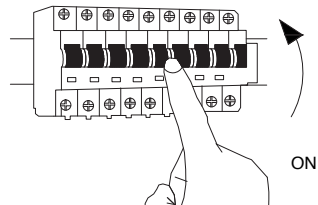

7. Turn on the general switch.

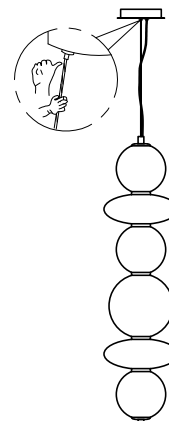

1. This light fitting operates at a normal supply voltage of 220-240V.
2. If the external flexible cable of the lamp is damaged, it shall be exclusively replaced by the manufacturer or his service agent or a similar qualified person in order to avoid hazard.