

NOVA LUCE

PRODUCT DATASHEET

Version: 001

PRODUCT PHOTOGRAPH



TECHNICAL DRAWING

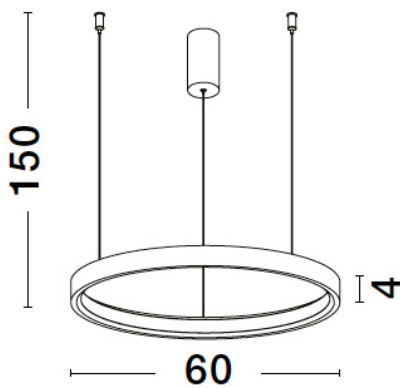

GENERAL INFORMATION

Product Code	9345618
Collection	Decorative
Product Category	Suspension
Product Family	Perrine
Mounting Location	Ceiling
Application Environment	Indoor

DIMENSION & WEIGHT

LxWxH (cm)	D: 60 H: 150
Cut out (cm)	N/A
Weight (Kgr)	2.4

MATERIAL & COLOR

Product Color	ed Champagne Silver
Body Material	Aluminium & Acrylic

APPLICATION & MOUNTING

Ambient Working Temp.	Max 45 oC
Type of Protection	IP20
Dimmable	Yes
Type of Dimming (Optional)	Triac
Mounting type	Ceiling
Mounting Depth (cm)	N/A
Led Module Replaceable	No
Light Source	LED

NOVA LUCE S.A

Schimatari Viotias
32009, Greece

+30 22620 58 121
+30 22620 56 743

info@novaluce.com
www.novaluce.com



NOVA LUCE

PRODUCT DATASHEET

Version: 001

ELECTRICAL DATA

Power (Nominal)	40W
Input voltage (Nominal)	220-240Vac
Mains Frequency	50/60Hz

PHOTOMETRICAL DATA

Luminous Flux	2800 lm
Color Temperature	3000K
Light Color (Designation)	Warm White

WARRANTY

Warranty	3 Years
----------	----------------

CERTIFICATES

Certificates	CE,UKCA
--------------	----------------

