

Important Safety Instructions

Basic safety precautions should always be followed when installing, including the following:

1. Read instructions & check you have all the tools & accessories to complete the installation correctly.
2. Licensed electrician for installation only.
3. Always ensure the power is OFF and the fitting has cooled down before performing any maintenance, cleaning, changing the globe or adjustment to the fitting.
4. Do not install any luminaire near the heat source.
5. Do not exceed the nominal supply voltage or amperage ratings.
6. To avoid injury or damage to the fitting, please ensure that power leads and screws are secure before connecting the power.

Installation Instruction

Fig 1: Installation Spacing

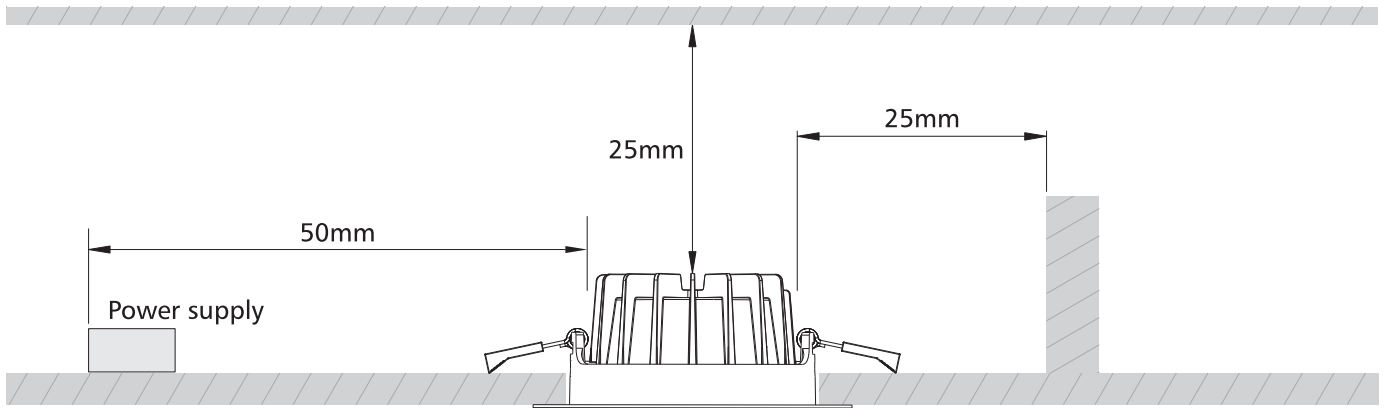

For Lamp:

RISK OF FIRE -- Required clearance from structural members and building elements
 SCB=25mm HCB=25mm MIC=0mm SCI=0mm

For LED driver:

RISK OF FIRE -- Required clearance from structural members and building elements
 SCB=25mm HCB=25mm MIC=25mm SCI=25mm

HCB: Height clearance to building element
 MIC: Minimum insulation clearance
 SCI : Side clearance to insulation
 SCB: Side clearance to building element
 SCG(Side clearance to auxiliary equipent (control gear (CG))):50mm

ARNING-RISK OF OVERHEATING OR FIRE IF THE CLEARANCE DISTANCES

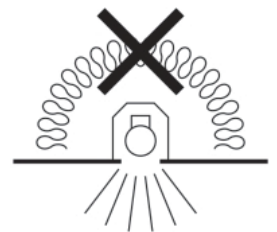

Ceiling cutout table

Downlight Dia (inch)	2.5	3	4	6
Ceiling Cutout (mm)	68-75	90-95	120-130	160-170

IP rating table: Before installation, please check the IP label on the luminaire to choose the right place to install.

IP20/IP40	Indoor use only, do not use in wet or damp place.
IP44/IP54	Suitable for indoor areas including bathrooms and covered/sheltered areas such as porches.

Dimmer selection table: Before installation, please check the information of driver as below.

Non-dim	Can not be used with any dimmer.
Triac dim	Compliable with recommended TRIAC dimmers, dimming range 8-100%.
0/1-10V	Only work with 0/1-10V dimming system, dimming range 8-100%.
DALI	Only work with DALI dimming system, dimming range 8-100%.

Installation Procedure

WARNING

1. Switch off before installation.
2. Switch on only after complete installation and examination of the circuit.
3. Professional electrician for installation and maintenance only.

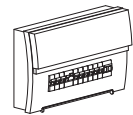

**Turn Off
Power Supply**

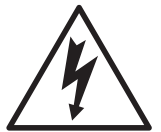

Downlight with external driver

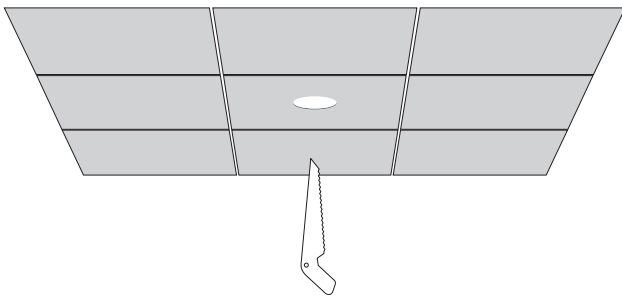

Cutout (refer to cutout table)

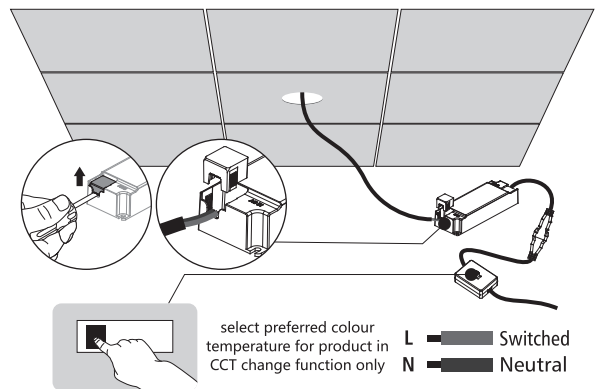

1. Create CutOut

If the external flexible cable or cord of this luminaire is damaged, it shall be exclusively replaced by the manufacturer or his service agent or a similar qualified person in order to avoid a hazard.

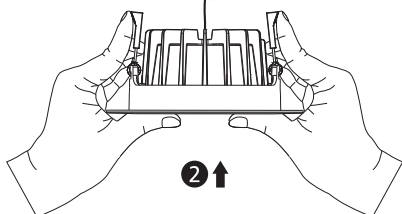

2. Adjust the colour temperature

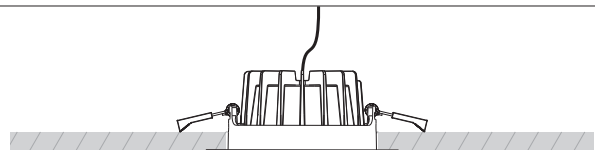

COMPLETE

The light source contained in this luminaire shall only be replaced by the manufacturer or his service agent or a similar qualified person.



4. Connect the wires & press the light into the ceiling