

NOVA LUCE

9136185, 9136186

1

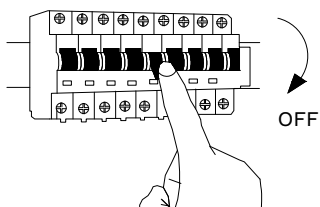

Turn off the general switch

2

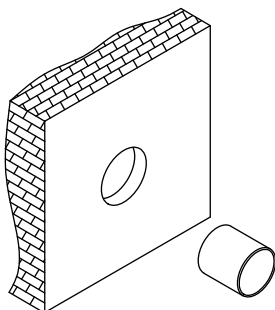

Mark where to create a CutOut

3

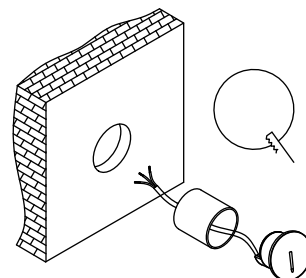

Create a CutOut

4

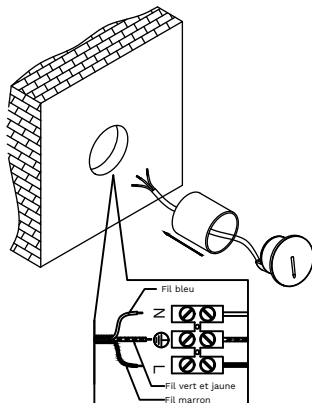

Connect wires

5

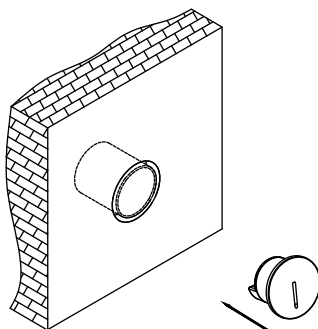

Connect parts together by tying it up into place

6

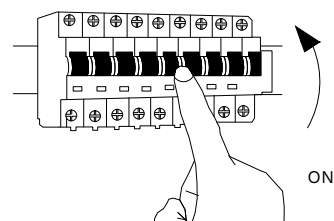

Turn on the general switch

7

