

Installation for track

①

Use wire stripper (TG-KXQ) to cover the track and divide it into 6 single wires according to wire trough.

②

Trim the excess portions of the four wires in the middle.

③

Strip off the outer covering of the steel wire rope and copper wires, being careful not to cut the steel wire rope.

④

Use copper tubing to connect the track wire and the external wire." (as shown on the right)

Prepare the terminals and stripped wires, and put the heat shrink tube on one end the wire

Locate the appropriate position and use pliers to firmly crimp the connector tube

⑤

Dimming signal line no need to be connected if it is non-DALI dimming

The middle 2 wires connected to DC24V circuits.

Insert the wires into the connector tube, aligning the two wires for a butt joint, ensuring that the copper tube is selected to be twice the size

Place the heat shrink tubing over the crimped area to finish crimping

⑥

Use TF05 and TF06 to clamp the wire rope up and down, be sure to tighten it and tighten the screws.

⑦

Thread the wire through the interior of TF03, rotate TF03, and align it with TF04 for proper coordination.

Main components of the tightener:

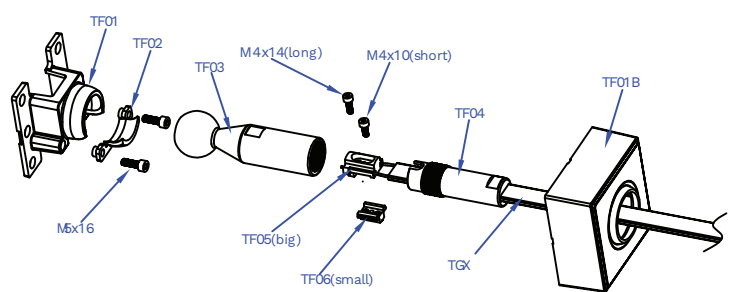

Wiring Instructions

1

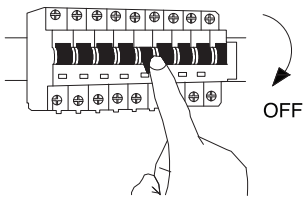

Turn off the general switch

2

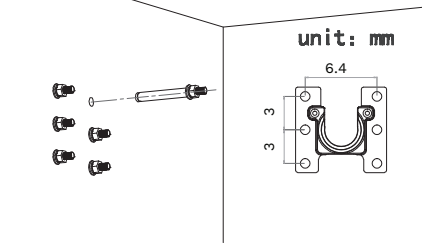

Apply the screws, mark & drill a hole

3

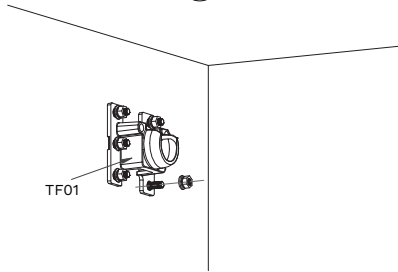

Fix well the base

4

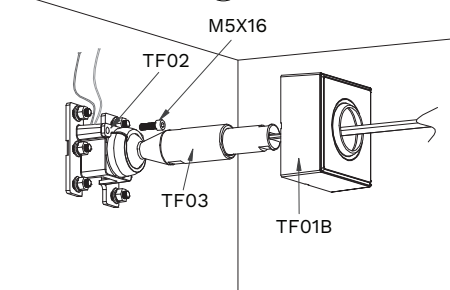

Fix the globular accessory by M5X16

5

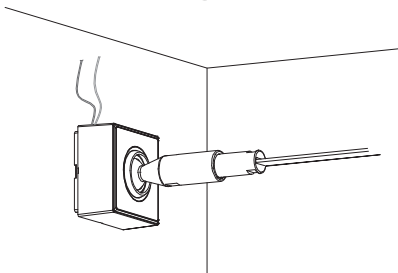

Cover TF01B onto TF02

6

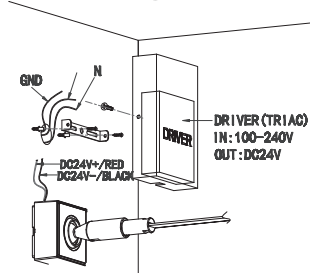

Connect wires for driver and track

7

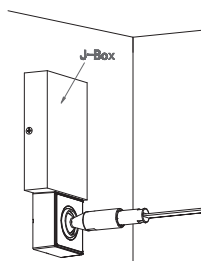

Apply the J-Box on the ceiling

8

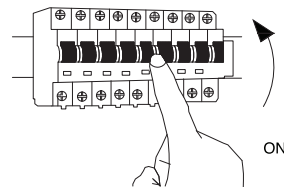

Turn on the general switch

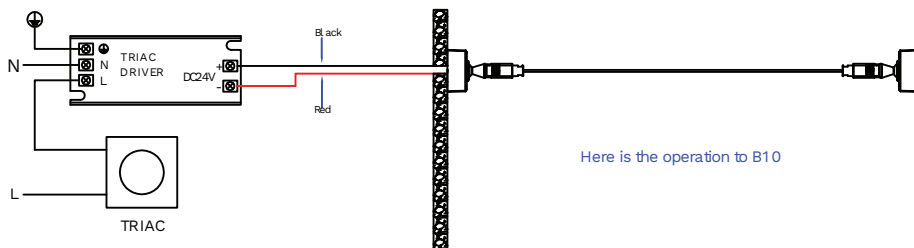

Connect two copper wires to the DC port of the power supply



Another Side Without Wiring

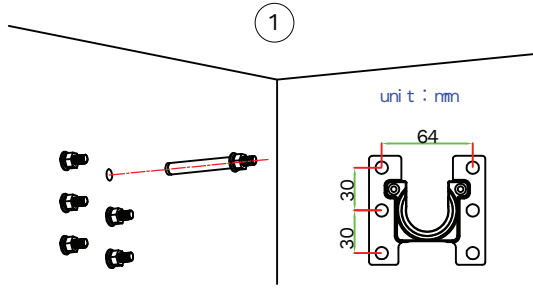

Fix the screw, tight up hole reference as shown on the right

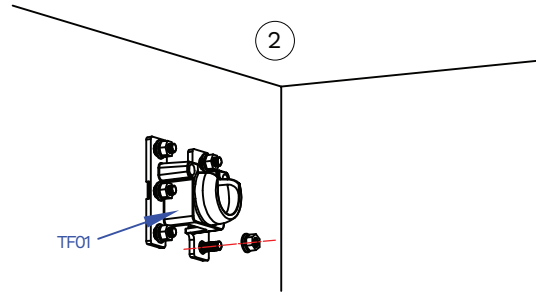

Fix well the base

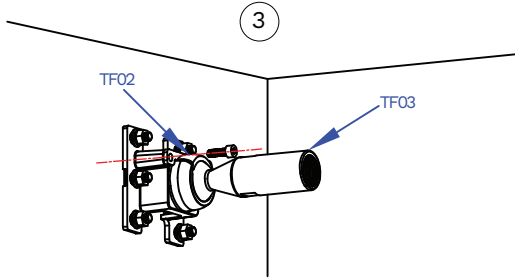

Fix the globular accessory by M5x16 (screw)

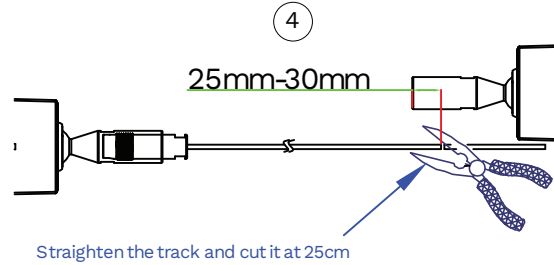

Straighten the track and cut it at 25cm

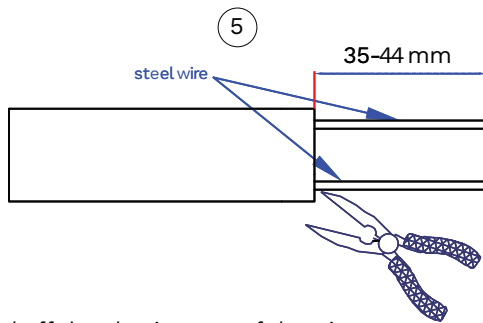

Peel off the plastic cover of the wires and expose the steel wire

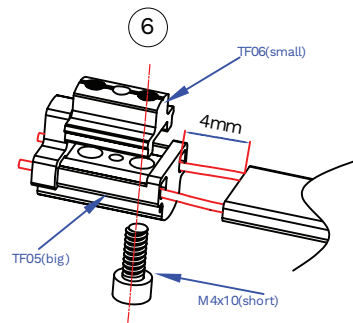

Nip the steel wire

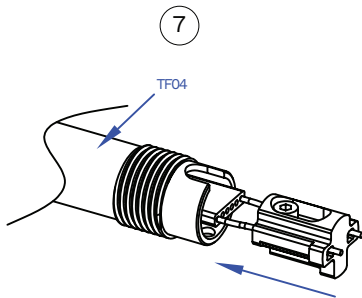

Insert the steel wire into TF04

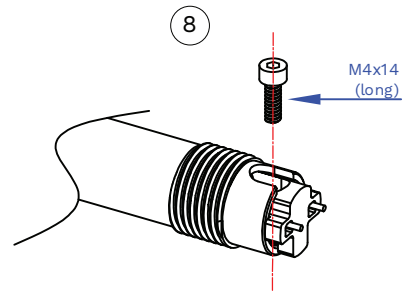

Use M4x14 screws fix thw wire in TF04

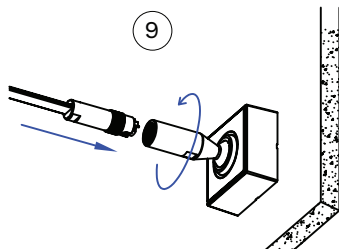

Rotate TF03 into TF04

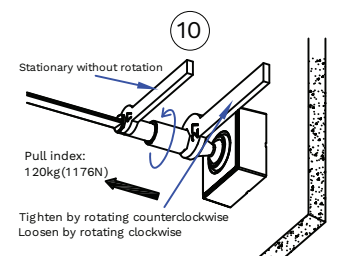

Tighten up



It is recommended to add messenger wire position

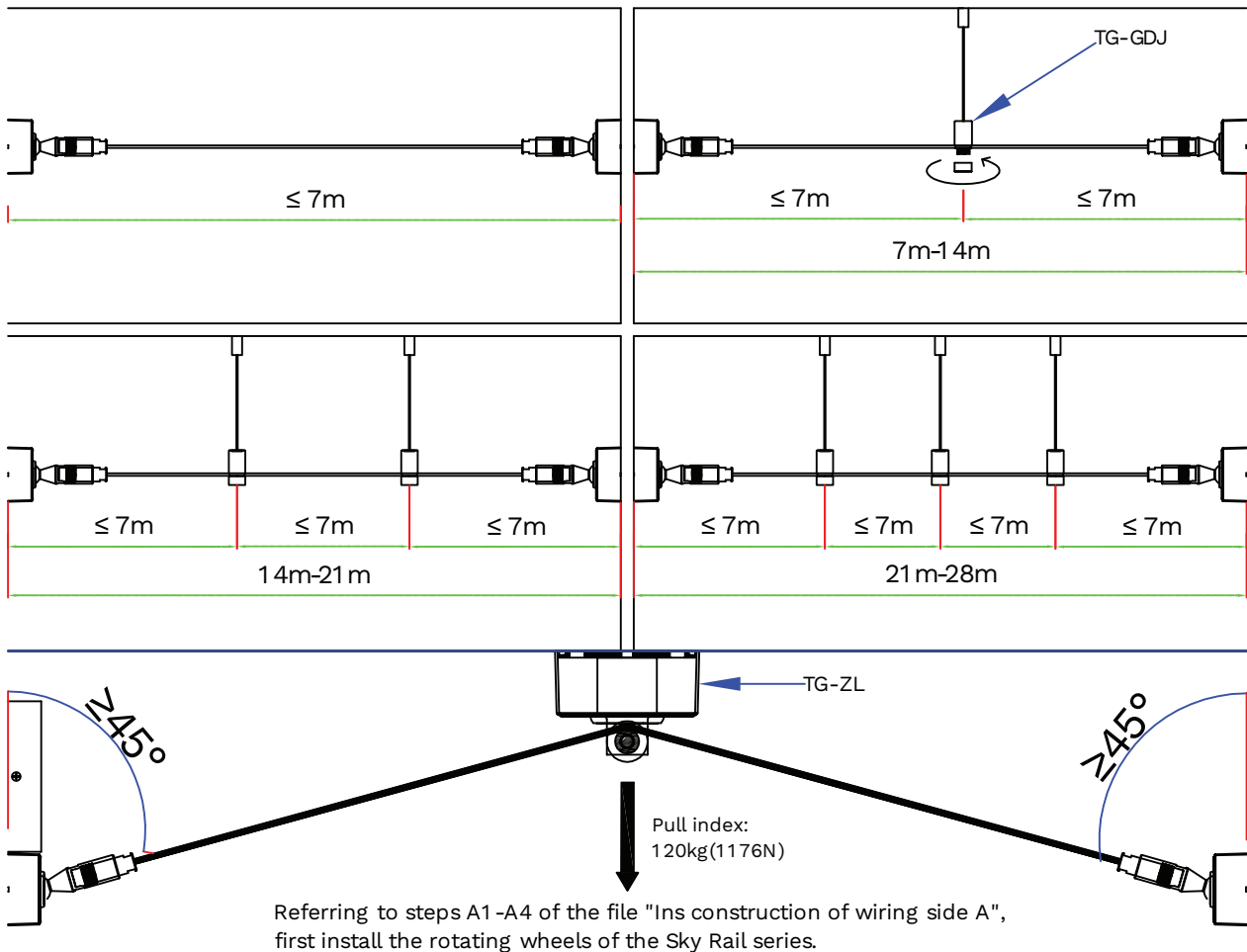
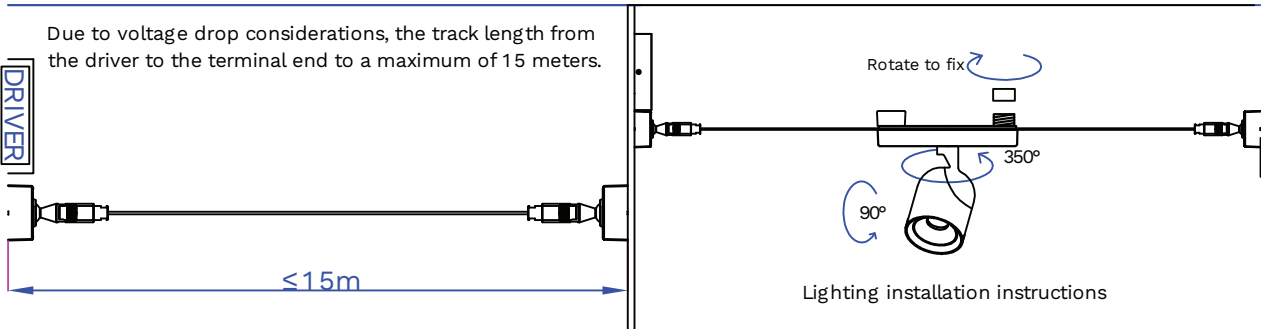
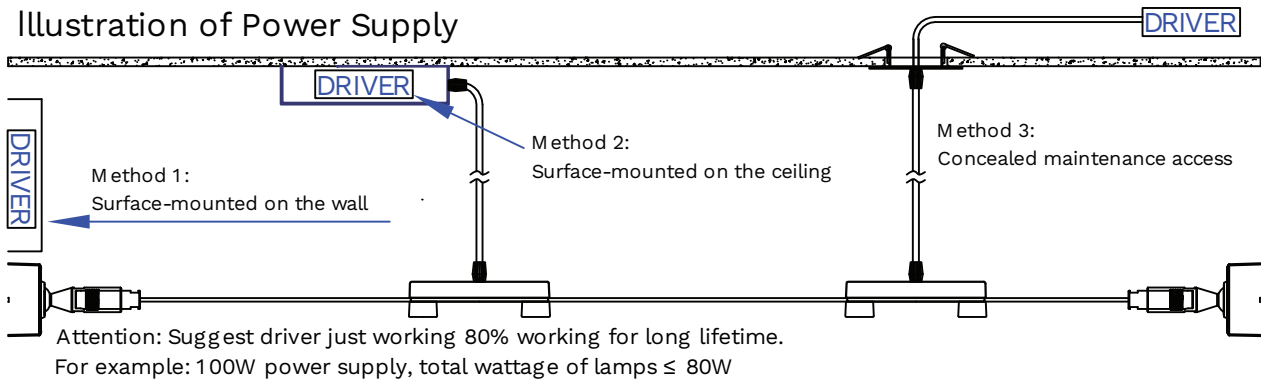

Illustration of Power Supply



Attention:

1. After tightening the track, the tensioner tension reaches 120kg (1176N). Before installation, please ensure that the wall or wallboard can withstand the tensile strength of the track.
2. Step B6, be sure to clamp the steel wire rope to ensure safety.
3. After tightening the steel wire rope, the total weight of the suspended fixture must not exceed 20 kilograms.
4. The light source contained in this luminaire shall only be replaced by the manufacturer or his service agent or a similar qualified person.
5. If the external flexible cable or cord of this luminaire is damaged, it shall be exclusively replaced by the manufacturer or his service agent or a similar qualified person in order to avoid a hazard.
6. The products shall be used with Class III track system certified with standard EN/IEC 60570, IP20, DC24V, shall not less than product's wattage.