

# NOVA LUCE

9088127

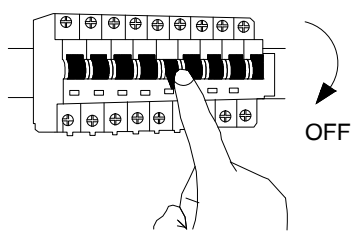

1. Turn off the general Switch

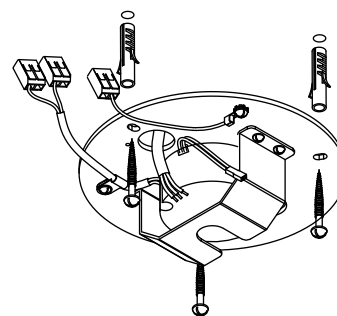

2. Align, mark and drill holes to apply the screws

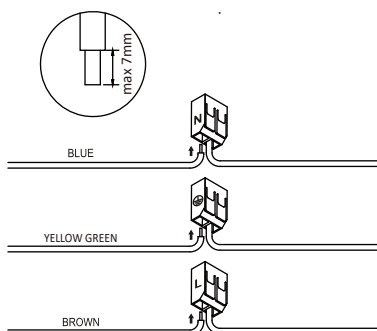

3. Connect the wires

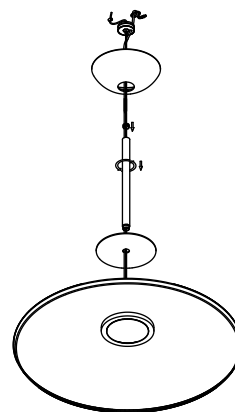

4. Assemble the parts by rotating them

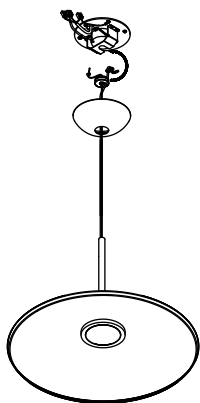

5. Insert the pendant onto place

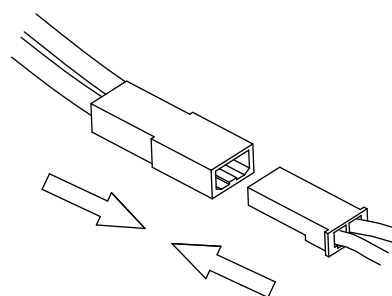

6. Plug wires in, by clicking them

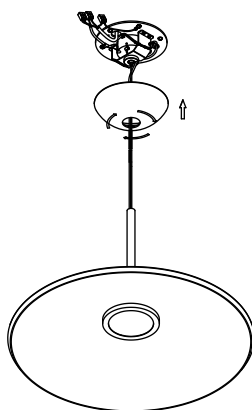

5. By rotating apply the canopy

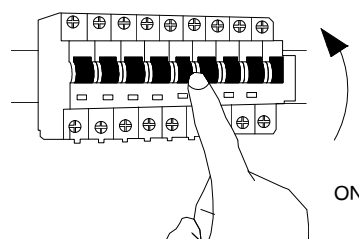

6. Turn on the general Switch