

1 Turn off the general Switch

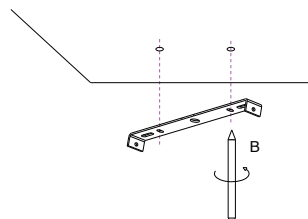

2 Align, where screws should be

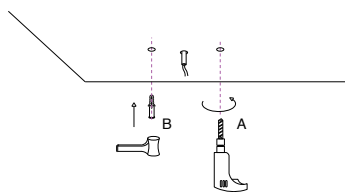

3 Apply plastic anchors

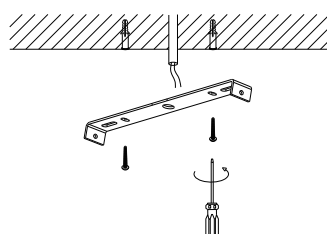

4 Apply screws to make it stable

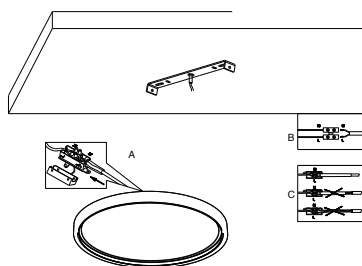

5 Connect the wires

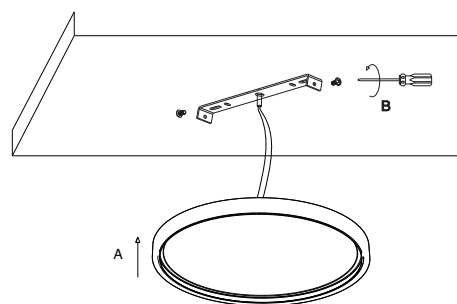

6 Apply the side screws

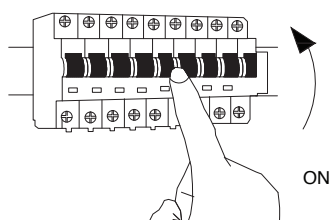

7 Turn on the general Switch

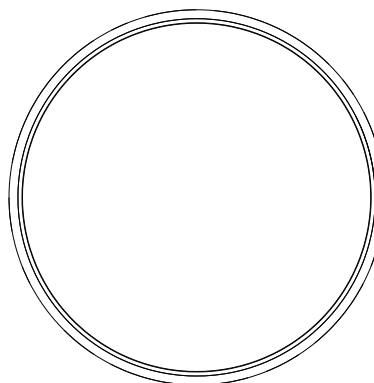

NOVA LUCE

Infrared remote control instructions

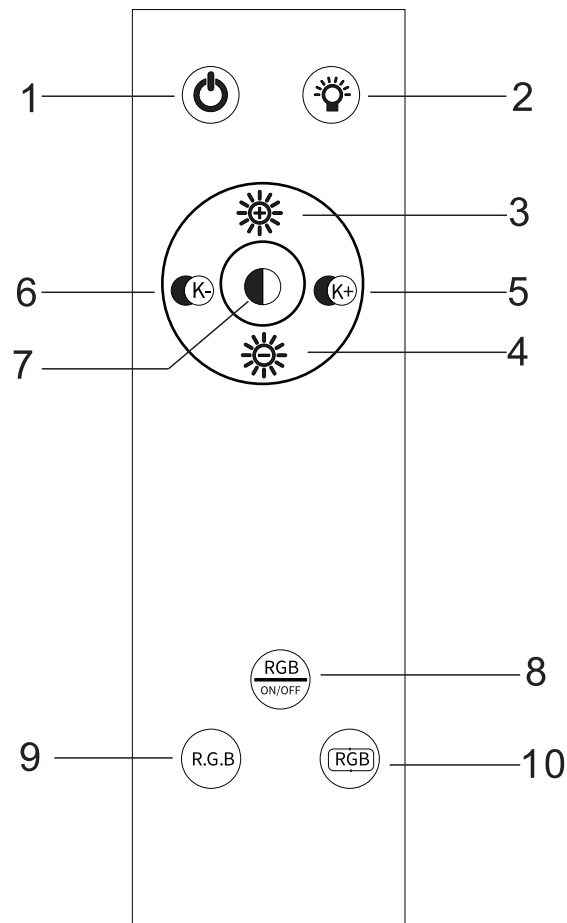

IR remote control:

1. 2pcs AAA battery
2. Control distance: No less than 5 meters (without barriers)
3. The control quantity of lamp is without limited as long as the fixture is at the distance.
4. Memory function

Function for each key

1. Main light source switch: press this button to turn on or off the main light source
2. Nightlight Mode: 10% brightness of Yellow light.
3. Brightness +: when the lamp is on, press and hold this button down to increase the brightness of the main light source
4. Brightness -: when the lamp is on, press and hold this button down to decrease the brightness of the main light source
5. Color temperature change gradually: Hold down this button, color to White
6. Color temperature change gradually: Hold down this button, color to Yellow
7. Color temperature change step by step: Yellow- Neutral-Cold
8. RGB on/off: turn RGB function on or off
9. RGB change: when the RGB function is on, press this button each time, and switch to next color
10. RGB change gradually: when the RGB function is on, press one time, the light will change through the colors gradually. Press one more time, the light will change the color one by one.