

NOVA LUCE

9701622

1

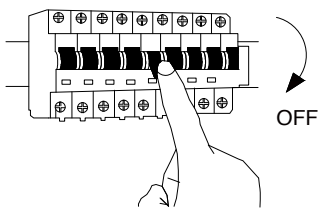

Turn off the general switch

2

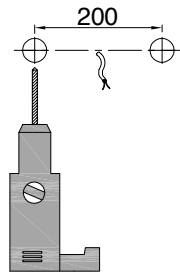

Drill holes

3

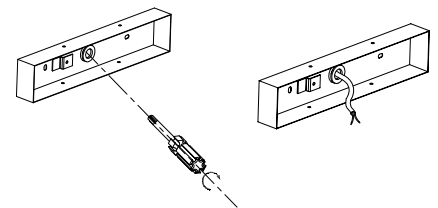

Get the wire through the hole

4

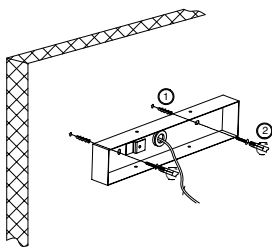

Get the wire through the hole & Apply plastic anchors with screws

5

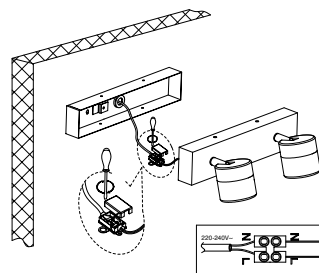

Connect the wires

6

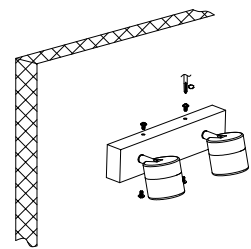

Apply all the nuts

7

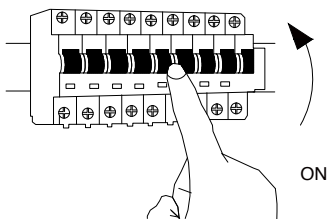

Turn on the general switch

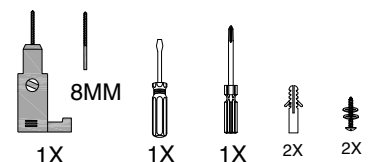
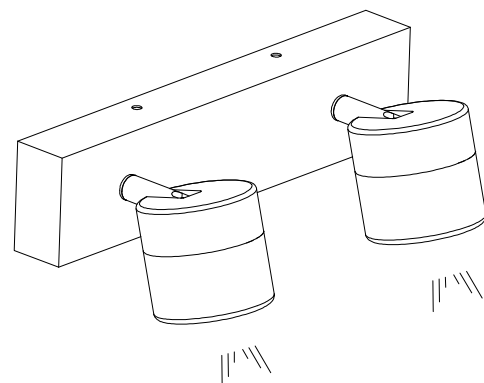

www.novaluce.com