

NOVA LUCE

9186970

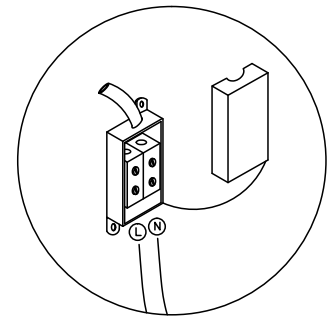

1. Turn off the general Switch
2. Align, mark and drill holes to apply the base on the ceiling
3. Connect the wires

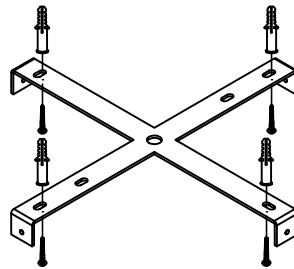
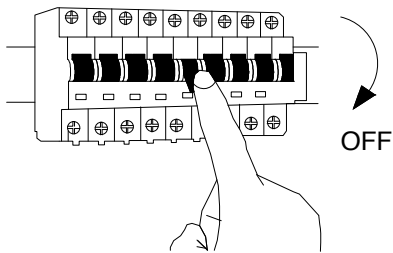
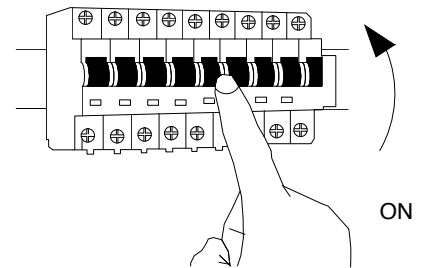
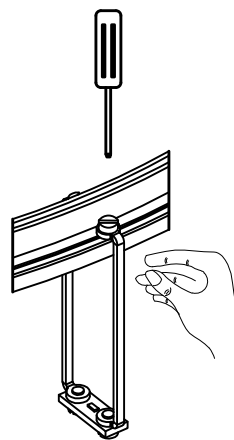
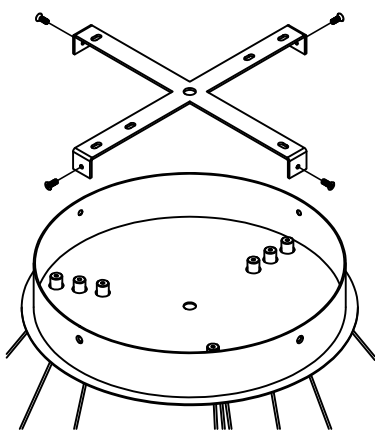

4. Fix the side screws

When the frames or LEDs are not straight, please loosen one screw and straighten them by hand, then tighten the screw.

5. Turn on the general Switch

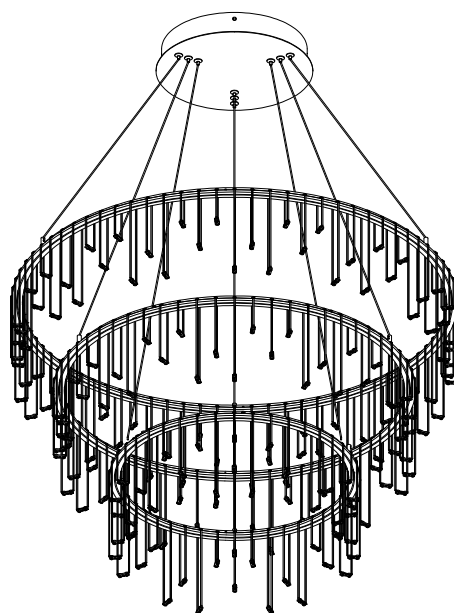

- a) This light fitting operates at a normal supply voltage of 220-240V.
- b) When changing the bulb or fuses, always switch off at the mains and allow the old bulb to cool down before handling.