

NOVA LUCE

9019761

1

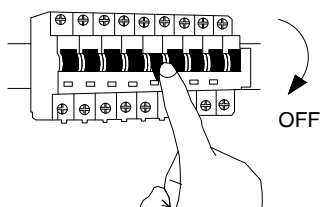

Turn off the general switch

2

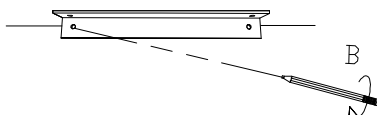

Mark & drill holes

3

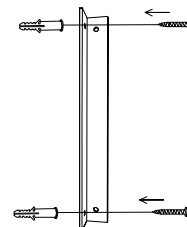

Apply plastic anchors with screws

4

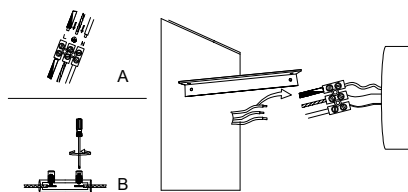

Connect wires

5

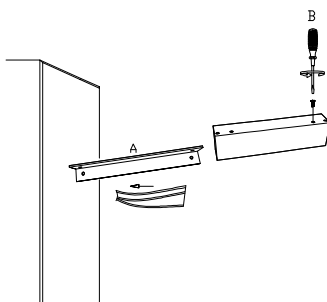

Apply the side screws

6

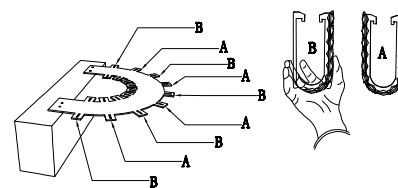

Align the two hooks of the crystal with the holes on the lamp body & fasten the hooks to A & B

7

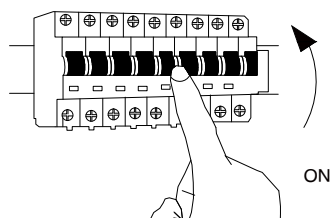

Turn on the general switch

