

# NOVA LUCE

9030515

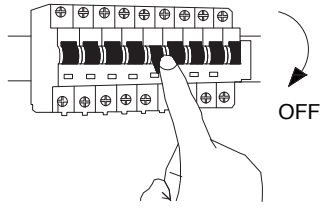

1. Turn off the general switch

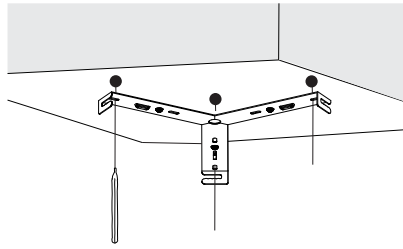

2. Align & mark

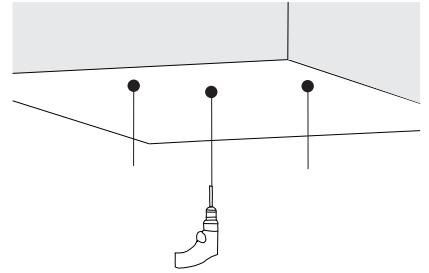

3. Drill holes on the marked areas

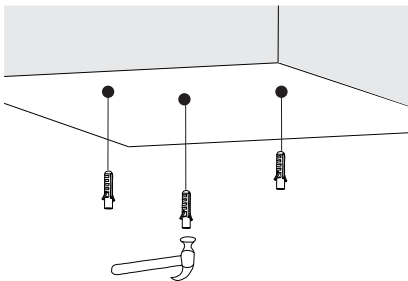

4. Apply plastic anchors

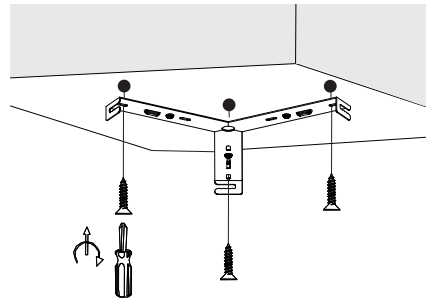

5. Apply the screws

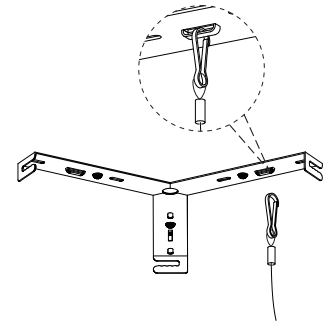

6. Place the element into place

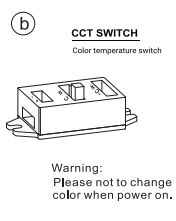
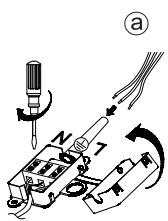

7. Connect the wires

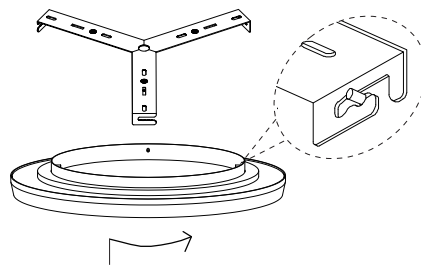

8. Fix the product in to place

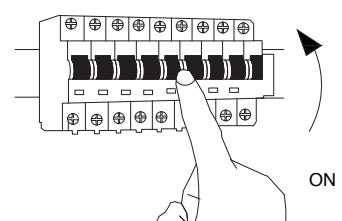

9. Turn on the general switch

