

NOVA LUCE

9122311, 9122321

1

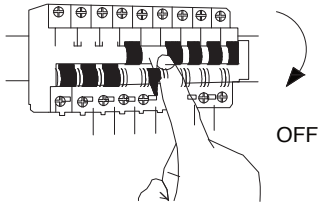

Turn off the general switch

2

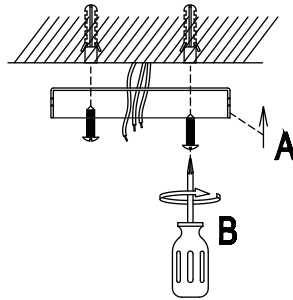

Drill holes, apply plastic anchors
& tie up screws with a screw driver

3

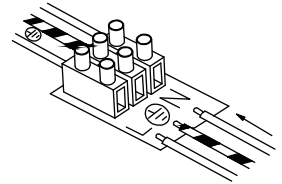

Connect the wires

Option A

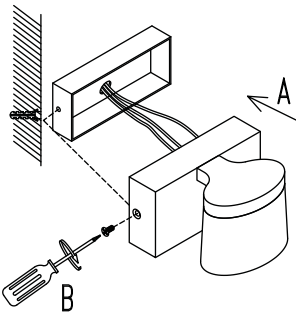

Fix it in place
& apply side screws

4

Option B

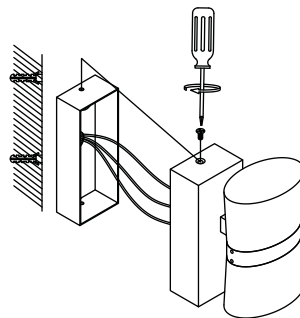

5

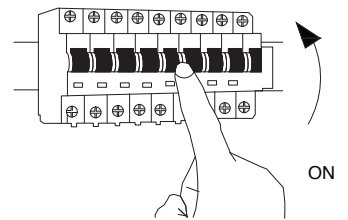

Turn on the general switch

6

Option A

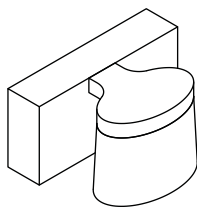

Option B

