

# NOVA LUCE

9030510

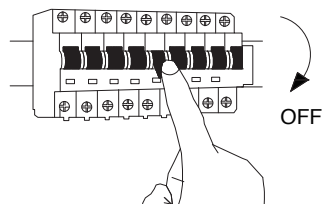

1. Turn off the general switch

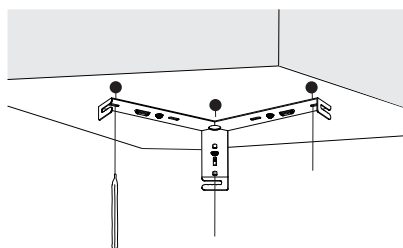

2. Align & mark

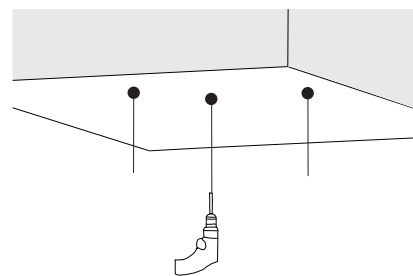

3. Drill holes on the marked areas

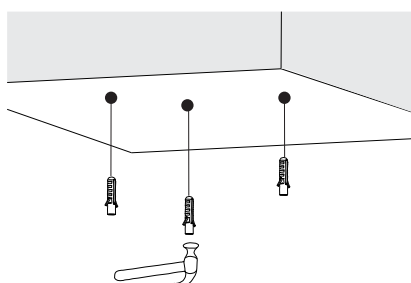

4. Apply plastic anchors

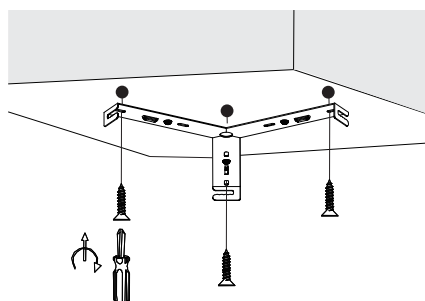

5. Apply the screws

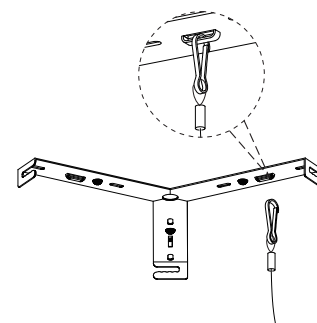

6. Place the element into place

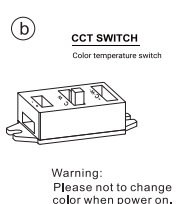
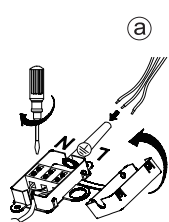

Warning:  
Please not to change  
color when power on.

7. Connect the wires

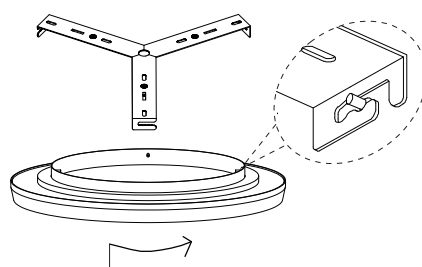

8. Fix the product in to place

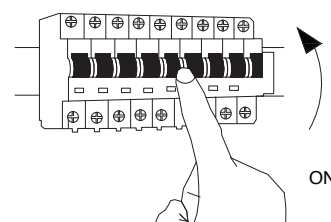

9. Turn on the general switch

