

# NOVA LUCE

## PRODUCT DATASHEET

Version: 001

### PRODUCT PHOTOGRAPH

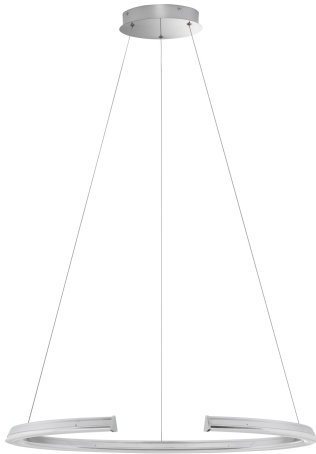

### TECHNICAL DRAWING

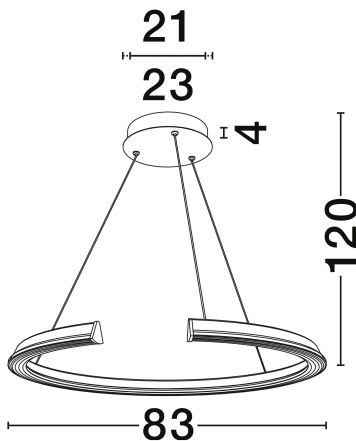

### GENERAL INFORMATION

Product Code	9019730
Collection	Indoor
Product Category	Suspension
Product Family	Elmo
Mounting Location	Wall
Application Environment	Indoor
Specifications	N/A

### DIMENSION & WEIGHT

LxWxH (cm)	D: 83 H: 120
Cut Out (cm)	N/A
Weight (Kgr)	2.8

### MATERIAL & COLOR

Product Color	Chrome
Body Material	Stainless Steel, Aluminium & Acrylic

### APPLICATION & MOUNTING

Ambient Working Temp.	Max 45°C
Type of Protection	IP20
Dimmable	Yes
Type of Dimming	Triac
Mounting type	Surface
Mounting Depth (cm)	N/A
Led Module Replaceable	No
Light Source	LED

NOVA LUCE S.A

Schimatari Viotias  
32009, Greece

+30 22620 58 121  
+30 22620 56 743

info@novaluce.com  
www.novaluce.com



# NOVA LUCE

---

## PRODUCT DATASHEET

Version: 001

---

### ELECTRICAL DATA

Power (Nominal)	<b>58W</b>
Input voltage (Nominal)	<b>220-240V</b>
Mains Frequency	<b>50/60Hz</b>

### PHOTOMETRICAL DATA

Luminous Flux	<b>3728lm</b>
Color Temperature	<b>3500K</b>
Light Color (Designation)	<b>Warm White</b>

### WARRANTY

Warranty	<b>3 Years</b>
----------	----------------

### CERTIFICATES

Certificates	<b>CE,UKCA</b>
--------------	----------------

