

NOVA LUCE

7403001

4 / 4

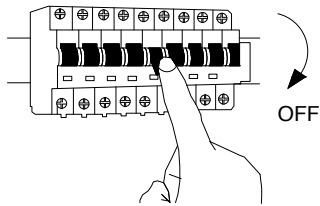

1. Turn off the general switch

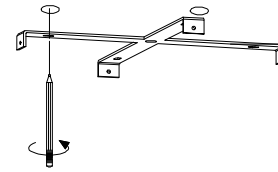

2. Align & Mark the areas

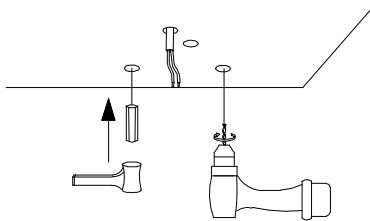

3. Drill on the mark areas

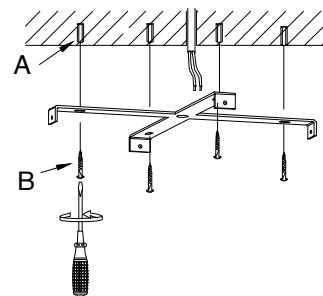

4. Apply the screws with the plastic anchors

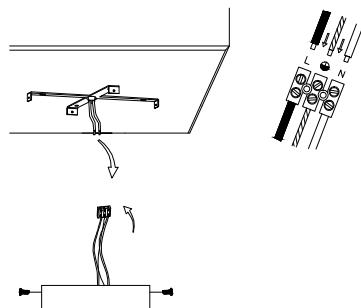

5. Connect the wires

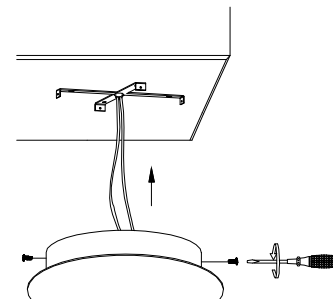

6. Apply the side screws

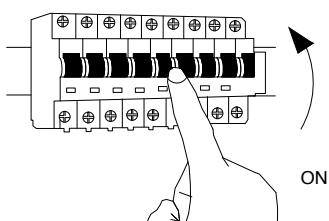

7. Turn on the general switch

