

1. Turn off the general switch

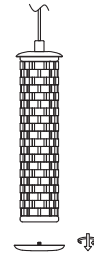

2. Unscrew the bottom part from the metal.

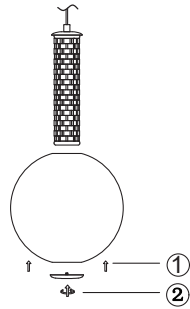

3. Insert the glass and screw it.

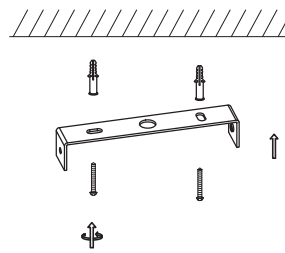

4. Drill holes and insert the screws into the base.

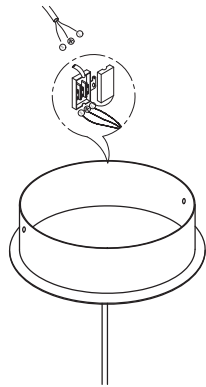

5. Connect wires.

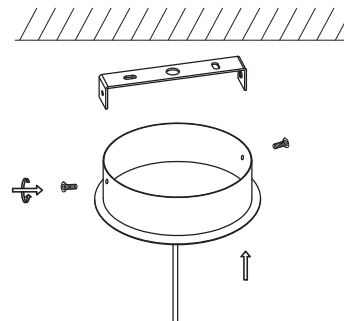

6. Tie up side screws.

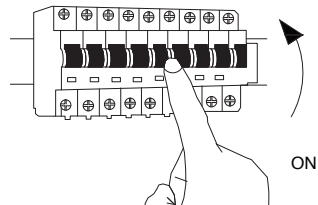

7. Turn on the general switch.

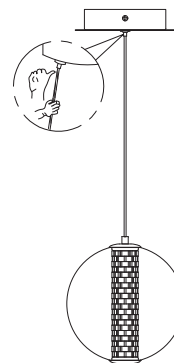

1. This light fitting operates at a normal supply voltage of 220-240V.
2. If the external flexdble cable of the lamp is damaged, it shall be exclusively replaced by the manufacturer of his service agent or a similar qualiad person in order to avoid hazard.