

1 Turn off the general Switch

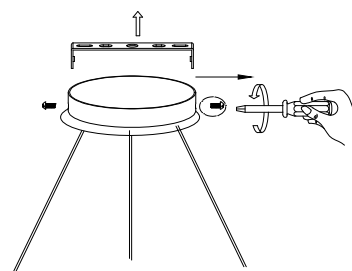

2 Untight side screws

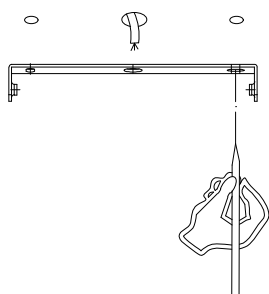

3 Align and mark

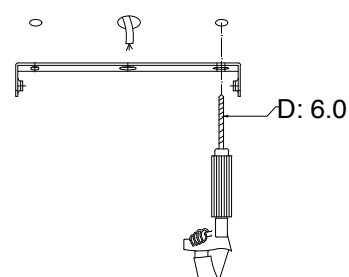

4 Drill holes

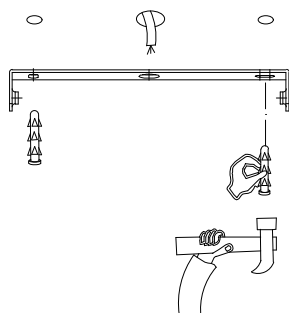

5 Apply plastic anchors and screws.

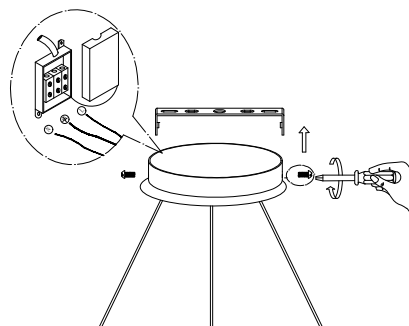

6 Connect the wires and apply the side screws

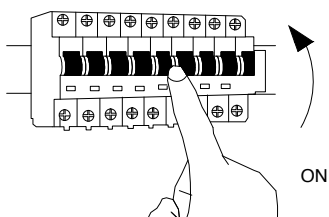

7 Turn on the general Switch

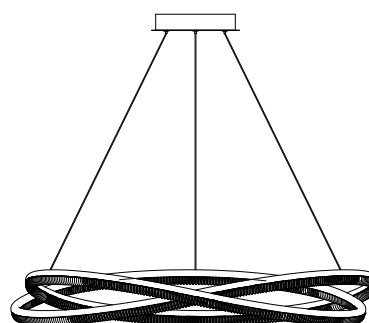

Please make sure to first install the lamp, prior to remove the protective film. Failure to do so can potentially lead to be scratched.