

# NOVA LUCE

9136446 9136447

1

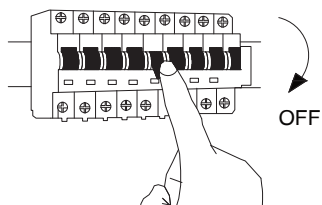

Turn off the general switch

2

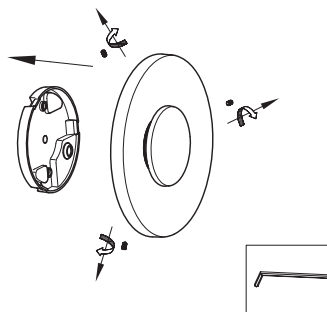

Dismantle parts by untying screws

3

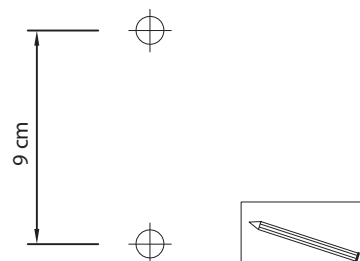

Mark holes

4

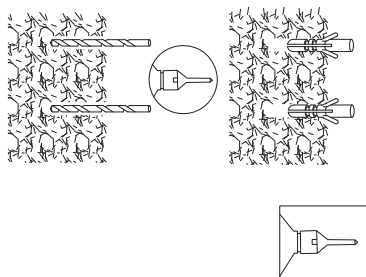

Drill holes & apply anchors

5

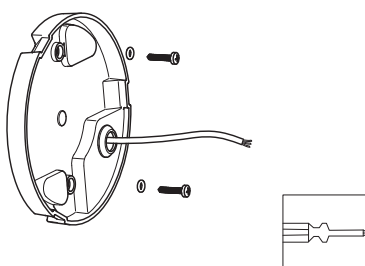

Tie up screws

6

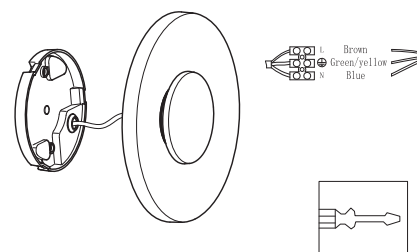

Connect wires

7

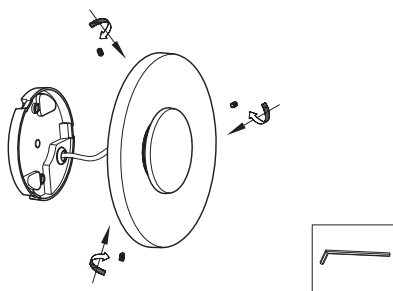

Tie up screws to make it stable

8

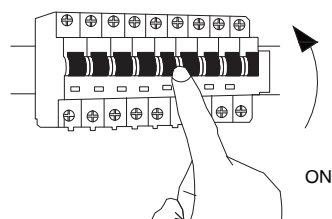

Turn on the general switch

9

