

NOVA LUCE

9267018 9267021

1

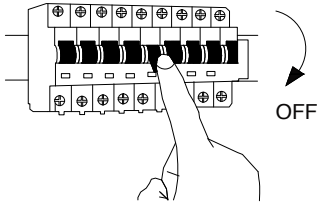

Turn off the general switch

2

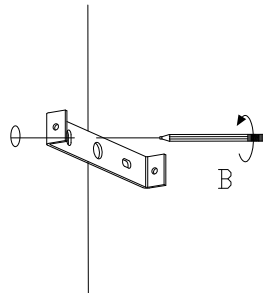

Mark where to drill holes

3

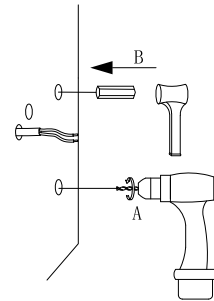

Make holes & apply anchors

4

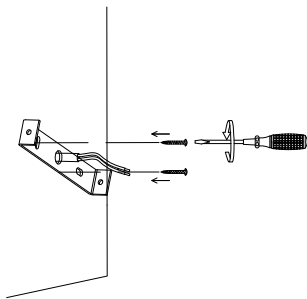

Tie up the screws
To make it stable

5

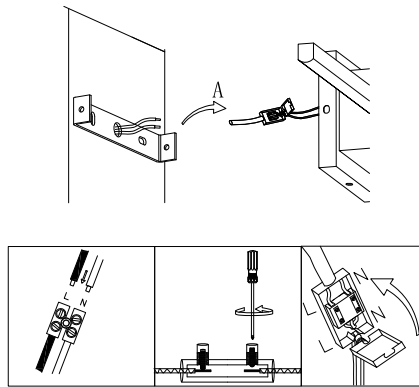

Connect the wires

6

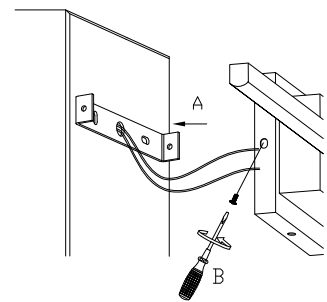

Apply side screws

7

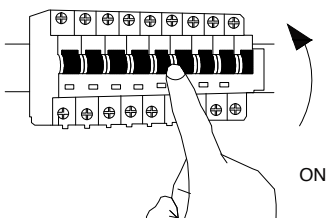

Turn on general switch

