

NOVA LUCE

9756716

1

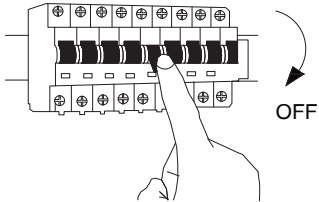

Turn off the general switch

2

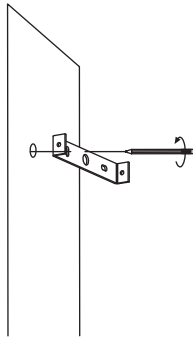

Mark where to drill holes

3

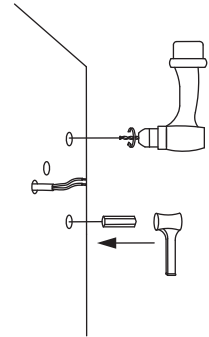

Make holes & apply anchors

4

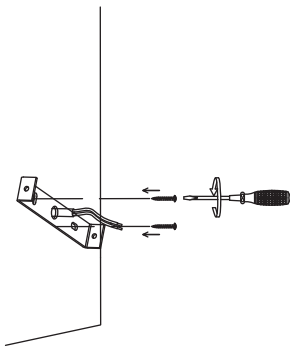

Tie up the screws to make it stable

5

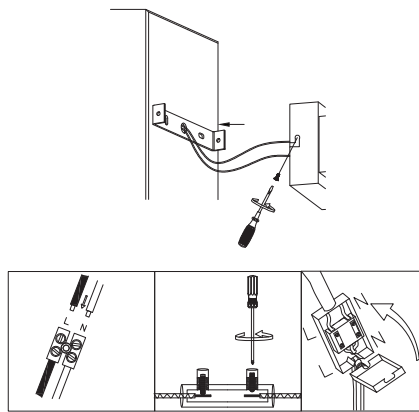

Connect the wires

6

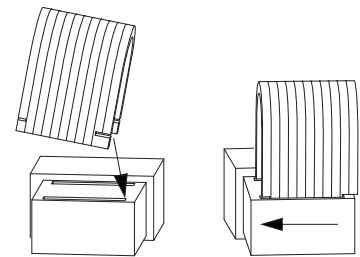

Insert the luminaire into place by placing it into place & sliding it in

7

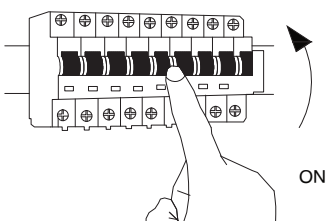

Turn on the general switch

8

