

1. Turn off the general Switch

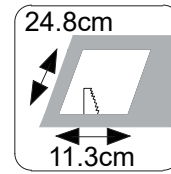

2. Create a Cut Out

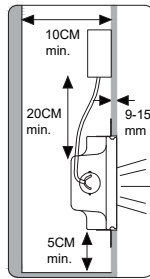

3. Take dimensions into consideration

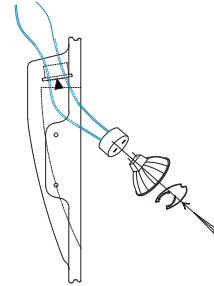

4. Insert bulb by rotate

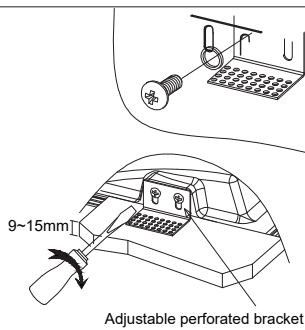

5. Apply screws into brackets

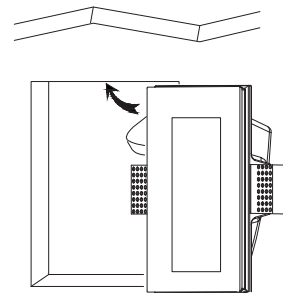

6. Fix it into place

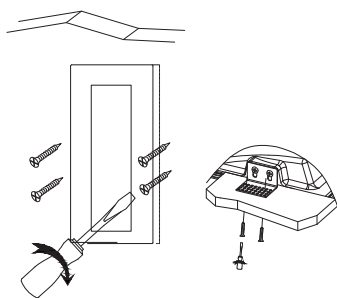

7. Apply screws

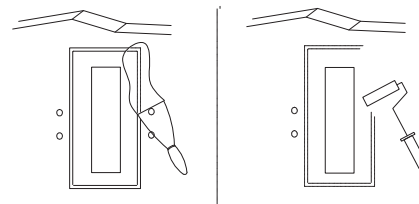

8. Apply putty powder to complete the installation

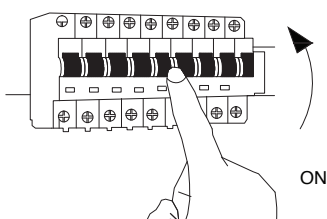

9. Turn on the General Switch