

# NOVA LUCE

9492540

1

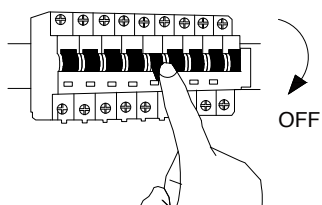

Turn off the general switch

2

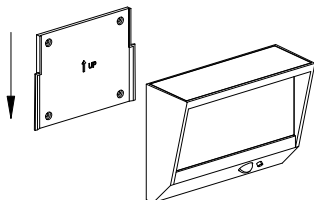

Remove the element

3

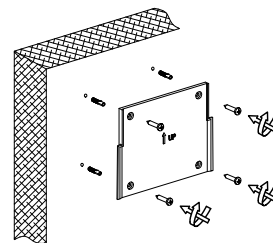

Drill holes & apply plastic anchors  
With screws

4

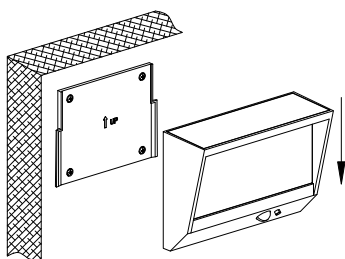

Apply the element in to place

5

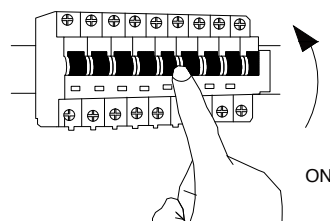

Turn on the general switch

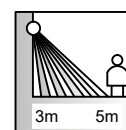
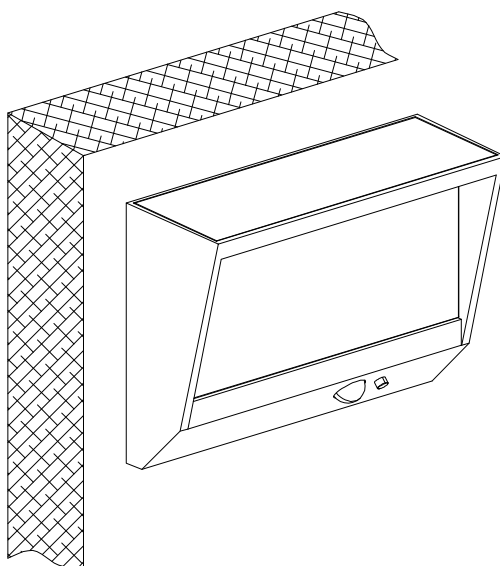

Infrared motions induction,  
the induction distance  
is about 3-5 meters

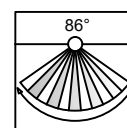

Induction Angle,  
around 86 degrees