

# NOVA LUCE

9756720, 9756721

1

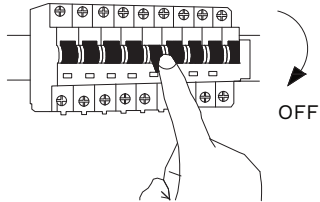

Turn off the general switch

2

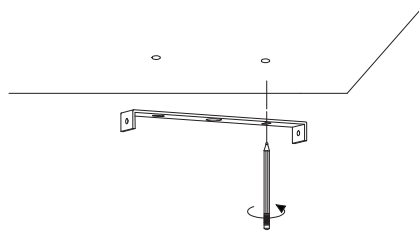

Mark where to drill holes

3

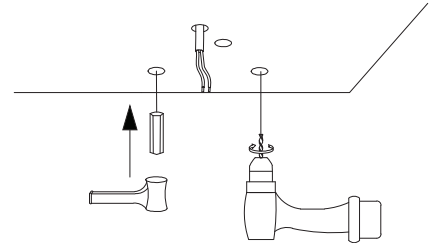

Make holes & apply anchors

4



Tie up the screws  
To make it stable

5

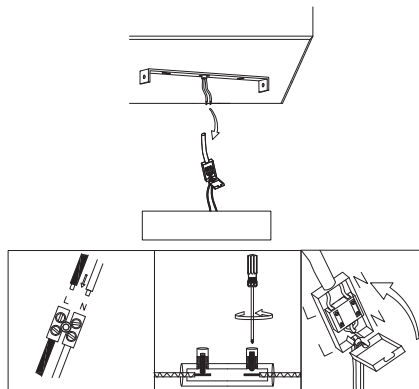

Connect the wires

6

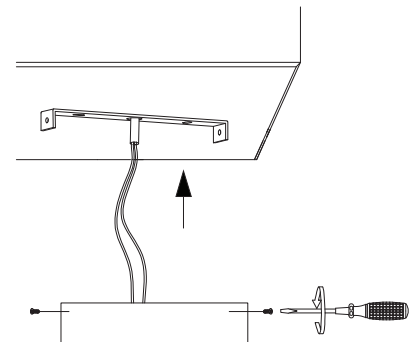

Fix the luminaire into place  
By tying up the side screws

7

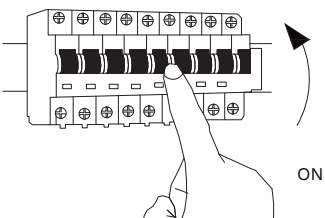



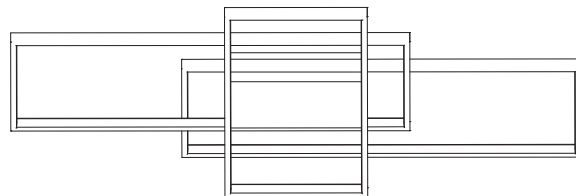



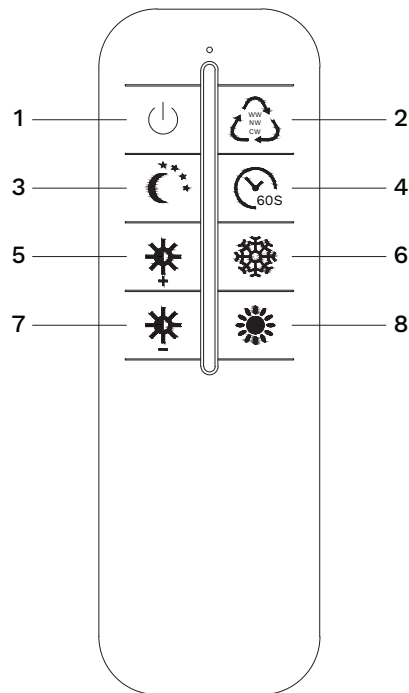

Turn on the general switch



## 2.4G REMOTE CONTROL INSTRUCTIONS



1.  ON/OFF Switch: Switch on light, within three seconds and press this button once, if the light flashes three times, the pairing is successful.
2.  Color temperature switch: Yellow-Warm White-White.
3.  Nightlight mode: 10% brightness of Yellow light.
4.  Timing mode: Switches off the light after 60s.
5.  Brightness +: When the lamp is on, press and hold this button down to **increase** the brightness.
6.  Color temperature changes gradually: Hold down this button, to change the color to White.
7.  Brightness -: When the lamp is on, press and hold this button down to **decrease** the brightness.
8.  Color temperature changes gradually: Hold down this button, color to Yellow.

