

NOVA LUCE

9756714

1

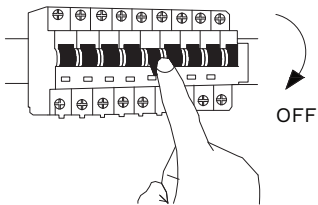

Turn off the general switch

2

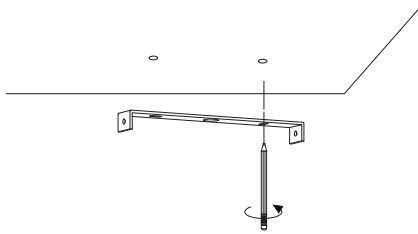

Mark where to drill holes

3

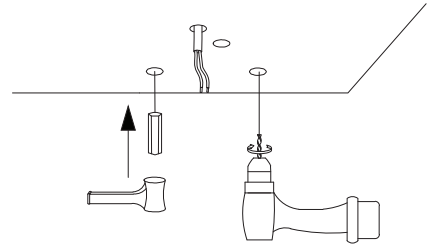

Make holes & apply anchors

4

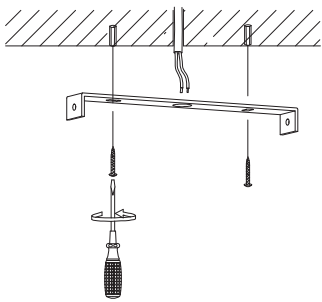

Tie up the screws to make it stable

5

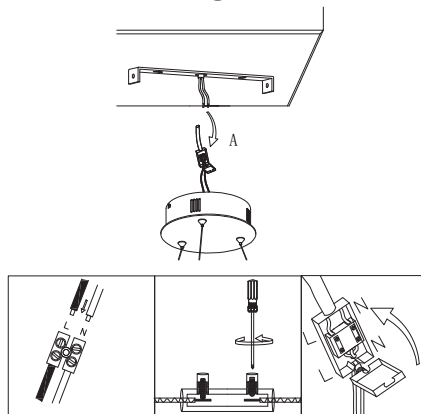

Connect the wires

6

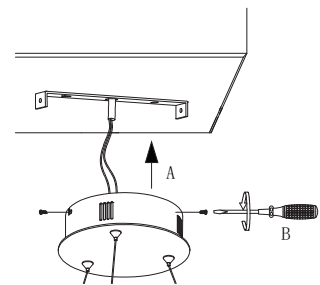

Fix the luminaire into place by tying up the side screws

7

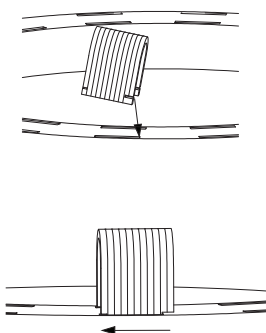

Apply the crystal

8

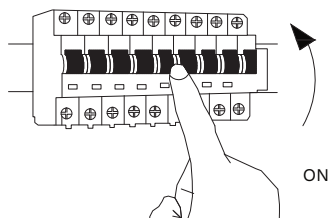

Turn on the general switch

